

**The new Marzocchi  
Low - noise and  
Low - ripple  
gear pump  
ELI2 multiple series**

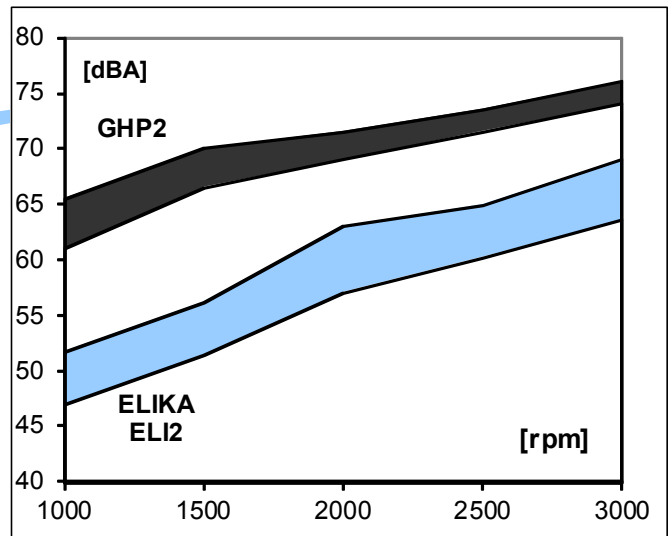

*ELIKA, Marzocchi's new proposal for the gear pump market, is a perfect fit for all those applications that require low noise levels. The use of ELIKA gear pump eliminates adverse noise effects on humans and on the surrounding environment. The ELIKA reduces the noise level by an average of 15 dBA compared with a conventional external gear pump. ELIKA is a patented product. Marzocchi extends the ELIKA family introducing multiple versions ELI2. ELI2 series, displacement from 7 to 35 cm<sup>3</sup>/rev.*

Marzocchi extends the family ELIKA introducing ELI2 multiple versions. The particular shape of the Elika profile patented by Marzocchi Pompe, eliminates the phenomenon of encapsulation typical of normal gear pumps, deleting the source of the main cause of noise and vibrations. The structure of the pump minimizes the internal leakage, maximizing the volumetric efficiency under all conditions. The low number of teeth reduces the fundamental frequencies of the pump noise, producing a more pleasant sound. The particular shape of the profile without encapsulation significantly reduces pressure-oscillations and vibrations produced by the pump and transmitted to the other components, reducing the noise of the hydraulic system. Axial forces induced by the helical teeth are optimally balanced in all operating conditions by the axial compensation system integrated in the pump cover. Specific compensation areas in the flange and cover, insulated by special gaskets reinforced with anti extrusion, allow for fully free axial and radial movement of the bushings. In this way, internal leakage is dramatically reduced, ensuring very good volumetric and mechanical pump performances, as well as proper lubrication of pump's moving parts. All single and multiple pumps ELIKA are available in both unidirectional rotating right and left, are available all major commercial versions of Group 2 as flanges, shafts and ports. Multiple pumps ELIKA have dimensions similar to the normal Marzocchi multiple pumps. The robust and compact internal connection system patented by Marzocchi, in addition to transmitting torque to the later stages, provides the right balance of axial helical gears. The very low noise level generated by the ELIKA pumps makes this product particularly suitable for those application where screw pumps, vane pumps or internal gear pumps are generally used.

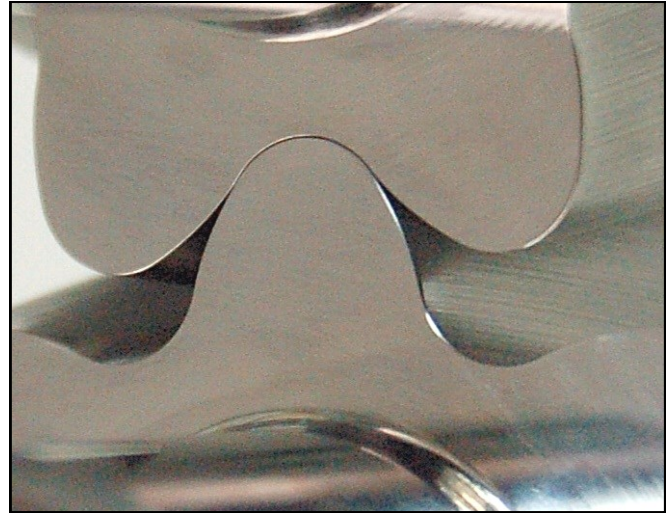

Noise pump comparison [dBA] Marzocchi GHP2 – ELIKA ELI 2, same displacement 17.8 cm<sup>3</sup>/rev.

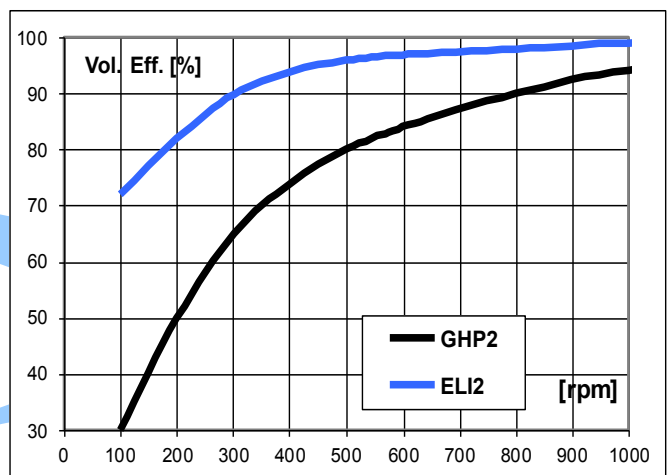

Comparison of volumetric efficiency at low rotation speed: Marzocchi GHP 2 – ELIKA ELI 2, displacement 17.8 cm<sup>3</sup>/rev; P = 200 bar.

### INSTALLATION NOTES

Please strictly follow assembly and use indications given in this catalogue for top performance, longer life and noise of the ELI Marzocchi series. Some general considerations should be made on the hydraulic system, in which the pump must be fitted. Special attention shall be devoted to hydraulic system design and assembly, especially to intake, delivery and return pipes and position of system parts (valves, filters, tanks, heat exchangers and accumulators). Proper safety devices and reliable instruments to avoid fluid turbulence, especially in return pipe to the tank, and prevent air, water and foreign bodies from entering into the system are of major importance. It is also very important to equip the hydraulic system with a proper filtering unit. Before starting the system on a continuous basis, we suggest to adopt some simple precautions: – Check for the direction of rotation of the pump to be consistent with the drive shaft of the prime mover. – Check for the proper alignment of pump shaft and motor shaft: it is necessary that the connection does not induce axial or radial loads. – Protect drive shaft seal during pump painting. Check if contact area between seal ring and shaft is clean: dust could provoke quicker wear and leakage. – Remove all dirt, chips and all foreign bodies from flanges connecting inlet and delivery ports. – Ensure that intake and return pipes are always below fluid level and as far from each other as possible. – Install the pump below head, if possible. – Fill the pump with fluid, and turn it by hand. – At first startup, set pressure limiting valves at min. value possible. – Avoid lower rotation speed than min. allowed with pressure higher than P1. – Do not start the system at low temperatures under load conditions or after long stops (always avoid or limit load starting for pump longer life. Start the system for a few minutes and turn on all components; bleed air off the circuit its proper filling. – Check fluid level in the tank after loading all components. – At last, gradually increase pressure, continuously check fluid and moving parts temperature, check rotation speed until you reach set operating values that shall be within the limits indicated in this catalogue.

### CLEANING AND FILTERING THE SYSTEM

It is widely known that most pumps early failures are due to contaminated fluids. The extreme reduction of the tolerances required in the design of the pumps and therefore their operation with minimum clearances, are heavily influenced by a fluid that is not perfectly clean. It is proved that particles circulating in the fluid act as abrasive agents, damaging the surfaces they touch and increasing the quantity of contaminant. For this reason, ensure that system is perfectly clean during startup and keep it clean for the whole operating life. Necessary interventions to check and limit contamination should be performed in a preventive and corrective way. Preventive actions include: proper cleaning of the system during assembly, deburring, eliminating the welding scum and fluid filtering before filling up. Starting contamination level of system fluid should not exceed class 18/15 (ref. ISO 4406). Even fresh fluids might exceed this contamination level; therefore always pre-filter the fluid when filling up or topping up the system. Fit a proper tank; its capacity should be proportional to the volume displaced by the pump in one working minute. Fluid contamination level check and correction during operation can be obtained through filters that retain the particles in the fluid. Two parameters tell which filter is most suitable: absolute filtering power and  $\beta$  filtering ratio. Low absolute filtering power and high  $\beta$  filtering ratio for small particles help ensuring good filtration. It is then very important to limit not only max dimensions, but also the number of smaller particles that pass through the filter. It goes without saying that with an operating pressure increase and according to the system sophistication degree, filtering should become more and more efficient. The filtering system shall always ensure contamination levels not exceeding the values indicates below.

Pressione	Pressure	< 140 bar	140 ÷ 210 bar	> 210 bar
Classe NAS 1638	NAS 1638 Class	10	9	8
Classe ISO 4406	ISO 4406 Class	19/16	18/15	17/14
Rapporto $\beta_x = 75$	Ratio $\beta_x = 75$	25 – 40 $\mu\text{m}$	12 – 15 $\mu\text{m}$	6 – 12 $\mu\text{m}$

### HYDRAULIC FLUIDS

Use specific mineral oil based hydraulic fluids having good anti-wear, anti-foaming (rapid de-aeration), antioxidant, anti-corrosion and lubricating proprieties. Fluids should also comply with DIN 51525 and VDMA 24317 standards and get through 11 stage of FZG test. For the standard models, the temperature of the fluid should be between  $-10^\circ\text{C}$  and  $+80^\circ\text{C}$ . Fluid kinematic viscosity ranges are the following:

Permessi (previa verifica)	Allowed value (upon verification)	6 ÷ 500 cSt
Raccomandati	Recommended value	10 ÷ 100 cSt
Consentiti all'avviamento	Value allowed at startup	< 2000 cSt

If fluids other than the above mentioned ones are used, please always indicate type of used fluid and operating conditions so that our Sales and Technical Dept. can weigh possible problems on compatibility or useful life of system parts.

**INLET PRESSURE**

Under standard working conditions, intake pipe pressure is lower than atmospheric pressure. The operating inlet pressure should range between 0.7 and 3 bars (absolute).

**INLET AND DELIVERY LINES**

Hydraulic system pipes should show no sudden changes of direction, sharp bends and sudden differences in cross-section. They should not be too long or out of proportion. Pipe cross-section should be sized so that fluid velocity does not exceed recommended values. It is advisable to carefully consider the possible diameter reduction of the inlet or outlet pipes fitted on flange fittings. Reference values are the following:

Condotto di aspirazione	Intake line	0.5 ÷ 1.6 m/s
Condotto di mandata	Delivery line	2.0 ÷ 6.0 m/s
Condotto di ritorno	Return line	1.6 ÷ 3.0 m/s

**PRESSURE DEFINITION**

Product tables show three max pressure levels [P1, P2, P3] to which each pump can be used.

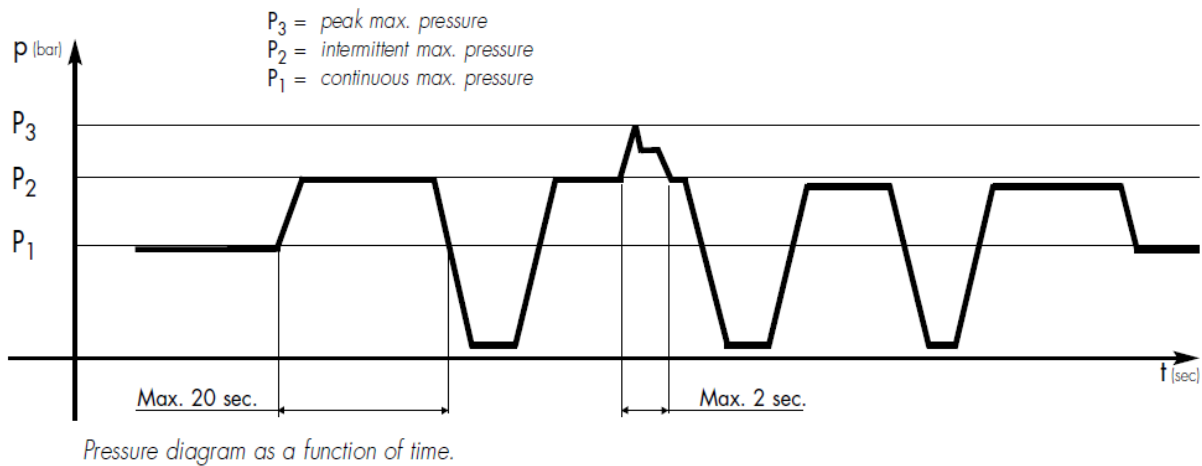

**DIRECTION OF ROTATION**

Marzocchi ELI series pumps are available in either clockwise or counter-clockwise rotation. Direction of rotation of single rotation pumps is conventionally defined as follows: when standing before the pump with driving shaft up with its projecting end towards the observer, the pump is rotating clockwise in case of right-hand rotation "D"; therefore, delivery side is on the right, whereas intake side is on the left: The contrary will happen with left-handed pumps "S", keeping the same point of view. The ELI pumps can not be modified in order to reverse the work rotation direction.

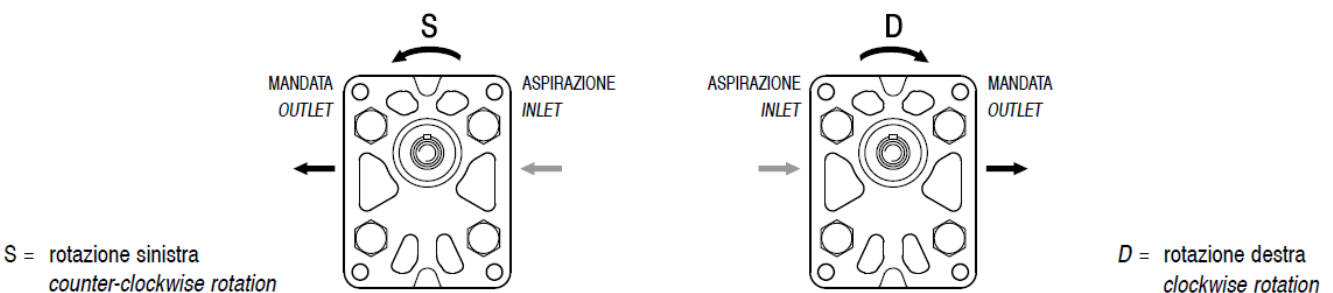

**DRIVE**

Connect the pump to the motor using either a flexible coupling (either box or Oldham coupling) so that no radial and/or axial force is transmitted to the pump shaft during rotation, otherwise pump efficiency will dramatically drop due to early wear of inner moving parts. Therefore, coupling must absorb inevitable-even though reduced-misalignment between pump shaft and motor shaft. Box coupling or Oldham coupling should also move axially freely enough (enough for proper contact surface onto pump driving shaft). Furthermore, to avoid early wear of either splined or Oldham couplings, they should be lubricated at regular intervals using specific grease. For further details please contact our Sales or Technical Depts.

**SEPARATE INLETS**

Standard modular multiple pumps feature communicating input areas. The AS option is available if the application requires non communicating input areas (at atmospheric pressure), like in two stage pump feeding two different fluids to two different circuits. This option features the use of one seal rings to separate the intake ports.

**SEALS**

“N” Standard version on NBR the temperature of the fluid should be between -10 °C and +80 °C.

“V” Fluorocarbon version suitable for fluid at high temperatures. Range between -10 °C and +120 °C. In the range between -10 °C and +80 °C pressures P1, P2 e P3 are possible as per product table; beside that P1 should not be exceeded.

**FREQUENTLY USED FORMULAS**

**Fluid velocity**

Calculate the velocity [v] of a fluid in a pipe as follows:

$$v = Q / 6 \times A \text{ [m/s]} \quad (1)$$

Q = flow rate [liter/min]

A = inside area of pipe [cm<sup>2</sup>]

**Delivered flow rate**

Calculate flow rate [Q] as follows:

$$Q = V \times n \times \eta_{vol} \times 10^{-3} \text{ [liter/min]} \quad (2)$$

V = displacement [cm<sup>3</sup>/rotation]

n = rotation speed [rpm]

$\eta_{vol}$  = pump volumetric efficiency (take 0.97 as an indicative value for rotation speeds ranging between 1000 and 2000 rpm)

**Absorbed torque**

Calculate necessary torque [M] of a pump subject to a pressure differential between inlet and delivery as follows:

$$M = (V \times \Delta P) / (62.8 \times \eta_{hm}) \text{ [Nm]} \quad (3)$$

V = displacement [cm<sup>3</sup>/rotation]

$\Delta P$  = pressure differential [bar]

$\eta_{hm}$  = hydromechanical efficiency (take 0.80 as indicative value under cold conditions and 0.85 under working conditions)

**Absorbed power**

Calculate hydraulic power [P] transferred to fluid from a pump subject to pressure differential between inlet and delivery as follows:

$$P = (Q \times \Delta P) / (600 \times \eta_{tot}) \text{ [kW]} \quad (4)$$

Q = flow rate [liter/min]

$\Delta P$  = pressure differential [bar]

$\eta_{tot}$  = total pump efficiency ( $\eta_{hm} \times \eta_{vol}$ )

Values for  $\eta_{vol}$  and  $\eta_{hm}$  (and consequently  $\eta_{tot}$ ) depend on pressure differential between inlet and delivery, rotation speed, fluid features (temperature and viscosity) and filtering degree. Call our Sales and Technical Dept. for further details on efficiency. The proper values for flow rate, torque and power absorbed according to pressure differential, rotation speed and set test conditions, can be found on the pages dedicated to the performance curves.

Pump Type	Displ. [cm <sup>3</sup> /rev]	Flow at 1500 [l/min]	Operating pressures			Rotation speed		Noise at 1500 giri/min*	
			P1 Max continuous [bar]	P2 Max intermittent [bar]	P3 Max peak [bar]	Minimum Speed [rpm]	Maximum speed [rpm]	On recirculation [dBA]	at P1 [dBA]
ELI2-7.0	7.0	10.5	280	295	310	300	4000	47	51
ELI2-8.2	8.2	12.3	280	295	310	300	4000	47	52
ELI2-9.6	9.6	14.5	280	295	310	300	4000	48	54
ELI2-11.4	11.4	17.1	280	295	310	300	4000	48	55
ELI2-14.0	14.0	21.0	260	275	290	300	4000	49	55
ELI2-16.1	16.1	24.1	260	275	290	300	4000	49	56
ELI2-17.8	17.8	26.7	260	275	290	300	4000	49	57
ELI2-21.0	21.0	31.5	230	245	260	200	3500	49	57
ELI2-23.7	23.7	35.5	230	245	260	200	3200	50	57
ELI2-25.7	25.7	38.6	210	225	240	200	3000	50	57
ELI2-28.0	28.0	42.1	200	215	230	200	2600	50	58
ELI2-35.0	35.1	52.6	150	165	180	200	2200	50	58

## How to order

PD ELI	TYPE	ROTATION	DISPL. FRONT STAGE	DISPL. REAR STAGE	SHAFT	FRONT STAGE PORTS	REAR STAGE PORTS	SEALS	OPTIONS
	2	D - CW	7.0	7.0	T0	D	D	N	-
	2A	S - CCW	8.2	8.2	T1	FA**	FA**	V	AS
	2BK1		9.6	9.6	T2				
	2BK2		11.4	11.4	C0				
	2BK4		14.0	14.0	C1				
	2BK7		16.1	16.1	C2				
			17.8	17.8	S0				
			21.0	21.0	S1				
			23.7	23.7	S2				
			25.7	25.7	S3				
			28.0	28.0	S4				
			35.0	35.0	G0				

### Pump standard types:

2	= european flange + shaft T0 + ports D + standard seals
2A	= flange A + shaft C1 + ports FA ** + standard seals
2BK1	= flange BK1 + shaft T1 + ports D + standard seals
2BK2	= flange BK2 + shaft T1 + ports D + standard seals
2BK4	= flange BK4 + shaft T1 + ports D + standard seals
2BK7	= flange BK7 + shaft G0 + port D + standard seals

### Examples:

PD ELI2-D-16.1/8.2-T0-D-D-N	= Double pump clockwise rotation, front stage 16.1 cm <sup>3</sup> /rev, rear stage 8.2 cm <sup>3</sup> /rev, European flange, 1:8 tapered shaft, flanged ports D type, standard seals.
PD ELI2A-D-28.0/14.0-S1-FA-FA-N	= Double pump clockwise rotation, front stage 28.0 cm <sup>3</sup> /rev, rear stage 14.0 cm <sup>3</sup> /rev, SAE flange, splined shaft S1, threaded ports FA**, standard seals.
PD ELI2BK1-S-8.2/8.2-T1-D-D-N	= Double pump counterclockwise rotation, front stage 8.2 cm <sup>3</sup> /rev, rear stage 8.2 cm <sup>3</sup> /rev, BK1 flange, 1:5 tapered shaft, flanged ports D type, standard seals.
PD ELI2BK7-D-35.0/7.0-G0-D-D-V-AS	= Double pump clockwise rotation, front stage 35.0 cm <sup>3</sup> /rev, rear stage 7.0 cm <sup>3</sup> /rev, BK7 flange, shaft G0, flanged ports D type, fluorocarbon seals, separate inlets.

The product data sheets show our standard model types. The synoptic tables for flanges, shafts and ports show all the possible configurations. For further details about the availability of each configuration please contact our Sales and Technical Dept.

\* Value based on ISO4412 test procedure

\*\* With thread ports on outlet side, a reduction of body fatigue strength may occur if the pump is working at elevated and intermittent pressures. For further details please contact our Sales and Technical Dept. we suggest to provide application specification through our PID form.

**ELI2**

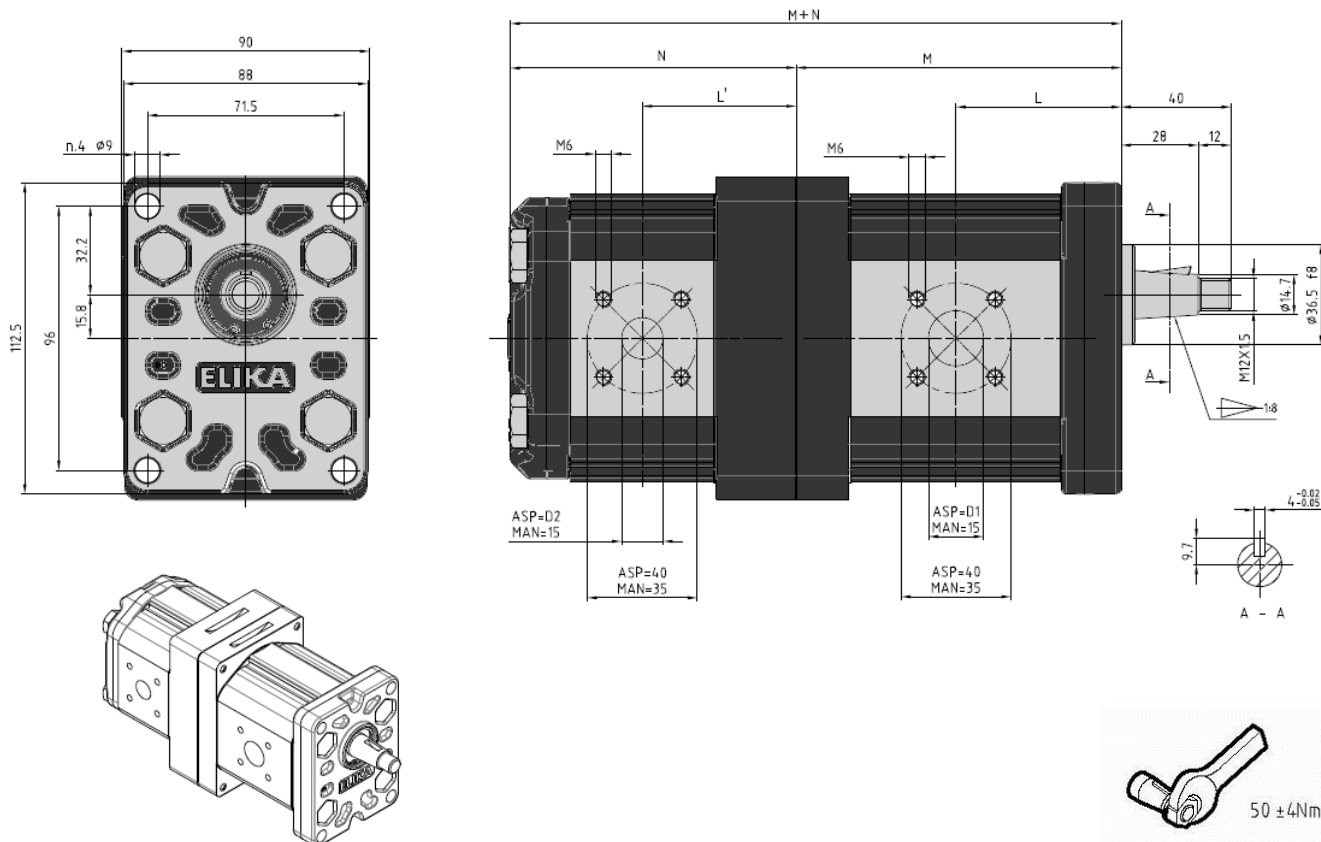

FRONT STAGE			
Pump Type	Displ. [cm <sup>3</sup> /rev]	Dimensions	
		L [mm]	M [mm]
ELI2-7.0	7.0	48.0	94.0
ELI2-8.2	8.2	49.0	96.0
ELI2-9.6	9.6	50.3	98.5
ELI2-11.4	11.4	51.8	101.5
ELI2-14.0	14.0	54.0	106.0
ELI2-16.1	16.1	55.8	109.5
ELI2-17.8	17.8	57.3	112.5
ELI2-21.0	21.0	60.0	118.0
ELI2-23.7	23.7	62.3	122.5
ELI2-25.7	25.7	64.0	126.0
ELI2-28.0	28.0	66.0	130.0
ELI2-35.0	35.1	72.0	142.0

REAR STAGE			
Pump Type	Displ. [cm <sup>3</sup> /rev]	Dimensions	
		L' [mm]	N [mm]
ELI2-7.0	7.0	64.5	112.5
ELI2-8.2	8.2	65.5	114.5
ELI2-9.6	9.6	66.8	117.0
ELI2-11.4	11.4	68.3	120.0
ELI2-14.0	14.0	70.5	124.5
ELI2-16.1	16.1	72.3	128.0
ELI2-17.8	17.8	73.8	131.0
ELI2-21.0	21.0	76.5	136.5
ELI2-23.7	23.7	78.8	141.0
ELI2-25.7	25.7	80.5	144.5
ELI2-28.0	28.0	82.5	148.5
ELI2-35.0	35.1	88.5	160.5

Accessories supplied with the standard pump: woodruff key (code 522057), M12x1.5 hexagonal nut (code 523016), washer (code 523005). Standard ports: M6 threads depth 13 mm. Please strictly follow assembly and use indications given in this catalogue for top performance and longer life of the ELI Marzocchi series. It is also very important to equip the hydraulic system with a proper filtering unit.

# ELI2A

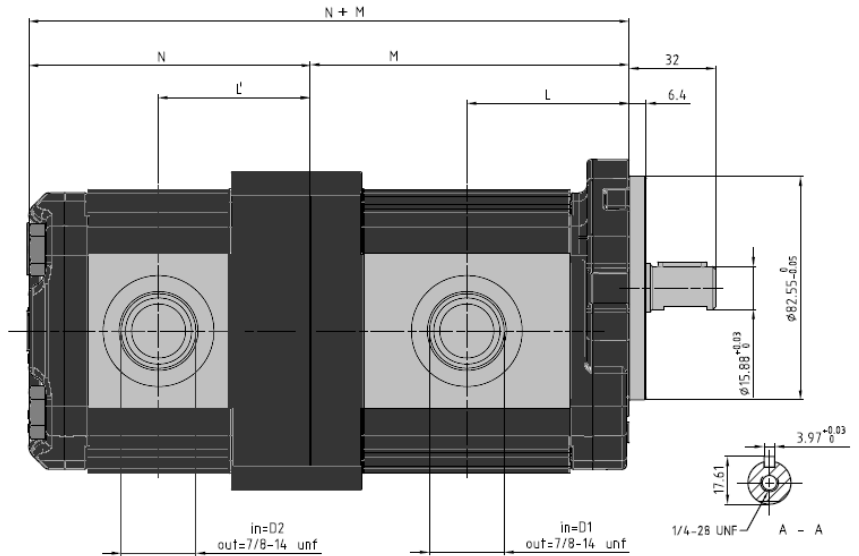
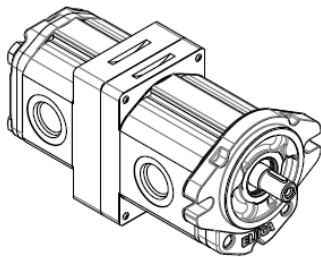
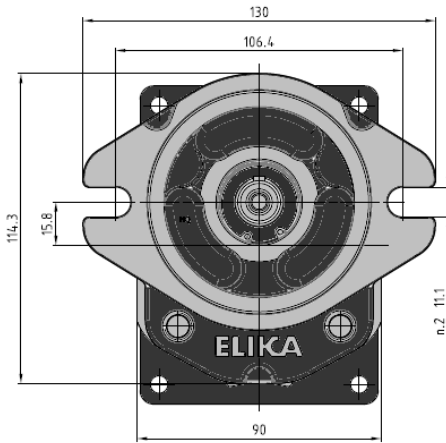

FRONT STAGE			
Pump Type	Displ. [cm <sup>3</sup> /rev]	Dimensions	
		L [mm]	M [mm]
ELI2-7.0	7.0	48.0	94.0
ELI2-8.2	8.2	49.0	96.0
ELI2-9.6	9.6	50.3	98.5
ELI2-11.4	11.4	51.8	101.5
ELI2-14.0	14.0	54.0	106.0
ELI2-16.1	16.1	55.8	109.5
ELI2-17.8	17.8	57.3	112.5
ELI2-21.0	21.0	60.0	118.0
ELI2-23.7	23.7	62.3	122.5
ELI2-25.7	25.7	64.0	126.0
ELI2-28.0	28.0	66.0	130.0
ELI2-35.0	35.1	72.0	142.0

REAR STAGE			
Pump Type	Displ. [cm <sup>3</sup> /rev]	Dimensions	
		L' [mm]	N [mm]
ELI2-7.0	7.0	64.5	112.5
ELI2-8.2	8.2	65.5	114.5
ELI2-9.6	9.6	66.8	117.0
ELI2-11.4	11.4	68.3	120.0
ELI2-14.0	14.0	70.5	124.5
ELI2-16.1	16.1	72.3	128.0
ELI2-17.8	17.8	73.8	131.0
ELI2-21.0	21.0	76.5	136.5
ELI2-23.7	23.7	78.8	141.0
ELI2-25.7	25.7	80.5	144.5
ELI2-28.0	28.0	82.5	148.5
ELI2-35.0	35.1	88.5	160.5

**\*\* With thread ports a reduction of body fatigue strength may occur if the pump is working at elevated and intermittent pressures.** Accessories supplied with the standard pump: key (code 522067). Mounting flange 82-2 (A) in compliance with SAE J744C. "D" and "d" ports are machined in compliance with threaded port with O-ring seal in truncated housing SAE J1926/1 (ISO 11926-1). Please strictly follow assembly and use indications given in this catalogue for top performance and longer life of the ELI Marzocchi series. It is also very important to equip the hydraulic system with a proper filtering unit.



**ELI2BK1**

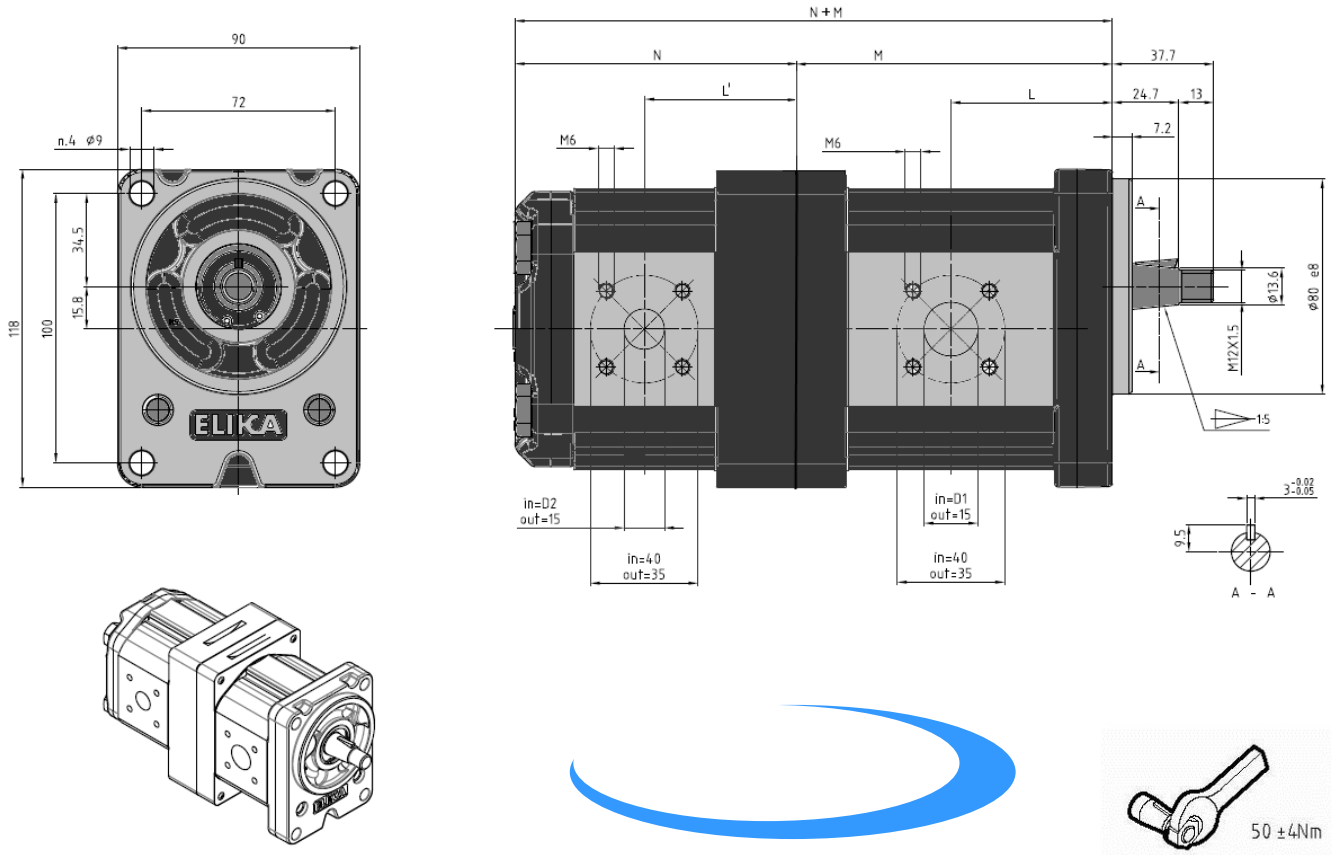

FRONT STAGE			
Pump Type	Displ. [cm <sup>3</sup> /rev]	Dimensions	
		L [mm]	M [mm]
ELI2-7.0	7.0	48.0	94.0
ELI2-8.2	8.2	49.0	96.0
ELI2-9.6	9.6	50.3	98.5
ELI2-11.4	11.4	51.8	101.5
ELI2-14.0	14.0	54.0	106.0
ELI2-16.1	16.1	55.8	109.5
ELI2-17.8	17.8	57.3	112.5
ELI2-21.0	21.0	60.0	118.0
ELI2-23.7	23.7	62.3	122.5
ELI2-25.7	25.7	64.0	126.0
ELI2-28.0	28.0	66.0	130.0
ELI2-35.0	35.1	72.0	142.0

REAR STAGE			
Pump Type	Displ. [cm <sup>3</sup> /rev]	Dimensions	
		L' [mm]	N [mm]
ELI2-7.0	7.0	64.5	112.5
ELI2-8.2	8.2	65.5	114.5
ELI2-9.6	9.6	66.8	117.0
ELI2-11.4	11.4	68.3	120.0
ELI2-14.0	14.0	70.5	124.5
ELI2-16.1	16.1	72.3	128.0
ELI2-17.8	17.8	73.8	131.0
ELI2-21.0	21.0	76.5	136.5
ELI2-23.7	23.7	78.8	141.0
ELI2-25.7	25.7	80.5	144.5
ELI2-28.0	28.0	82.5	148.5
ELI2-35.0	35.1	88.5	160.5

Accessories supplied with the standard pump: woodruff key (code 522055), M12x1.5 hexagonal nut (code 523016), washer (code 523005). Standard ports: M6 threads depth 13 mm. Please strictly follow assembly and use indications given in this catalogue for top performance and longer life of the ELI Marzocchi series. It is also very important to equip the hydraulic system with a proper filtering unit.

# ELI2BK2

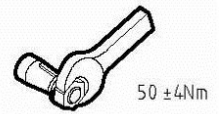
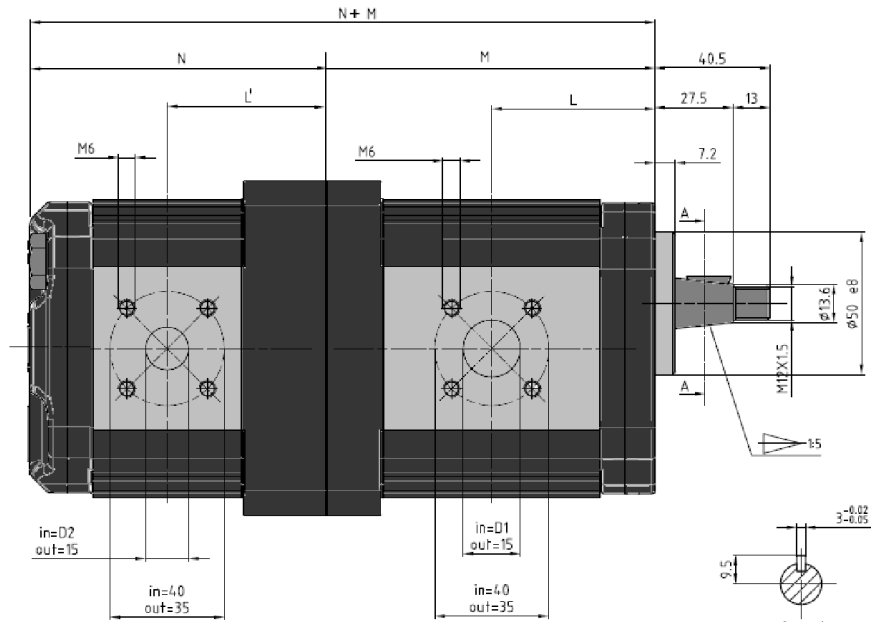
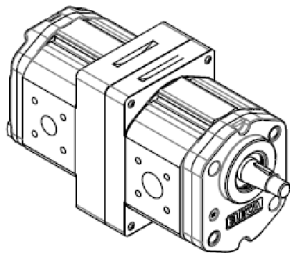
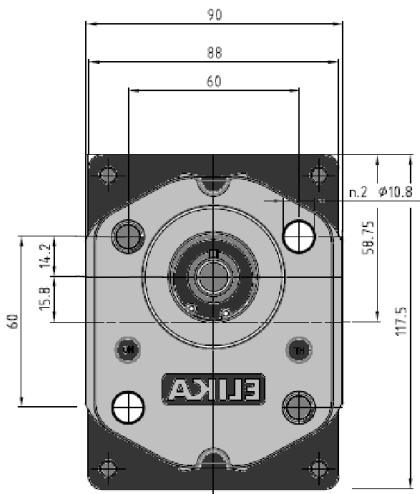

FRONT STAGE			
Pump Type	Displ. [cm <sup>3</sup> /rev]	Dimensions	
		L [mm]	M [mm]
ELI2-7.0	7.0	45.0	91.0
ELI2-8.2	8.2	46.0	93.0
ELI2-9.6	9.6	47.3	95.5
ELI2-11.4	11.4	48.8	98.5
ELI2-14.0	14.0	51.0	103.0
ELI2-16.1	16.1	52.8	106.5
ELI2-17.8	17.8	54.3	109.5
ELI2-21.0	21.0	57.0	115.0
ELI2-23.7	23.7	59.3	119.5
ELI2-25.7	25.7	61.0	123.0
ELI2-28.0	28.0	63.0	127.0
ELI2-35.0	35.1	69.0	139.0

REAR STAGE			
Pump Type	Displ. [cm <sup>3</sup> /rev]	Dimensions	
		L' [mm]	N [mm]
ELI2-7.0	7.0	61.5	109.5
ELI2-8.2	8.2	62.5	111.5
ELI2-9.6	9.6	63.8	114.0
ELI2-11.4	11.4	65.3	117.0
ELI2-14.0	14.0	67.5	121.5
ELI2-16.1	16.1	69.3	125.0
ELI2-17.8	17.8	70.8	128.0
ELI2-21.0	21.0	73.5	133.5
ELI2-23.7	23.7	75.8	138.0
ELI2-25.7	25.7	77.5	141.5
ELI2-28.0	28.0	79.5	145.5
ELI2-35.0	35.1	85.5	157.5

Accessories supplied with the standard pump: woodruff key (code 522055), M12x1.5 hexagonal nut (code 523016), washer (code 523005). Standard ports: M6 threads depth 13 mm. To mount the pump: n°2 M10 screws with a torque wrench setting fixed at 46±4 Nm. Please strictly follow assembly and use indications given in this catalogue for top performance and longer life of the ELI Marzocchi series. It is also very important to equip the hydraulic system with a proper filtering unit.

**ELI2BK4**

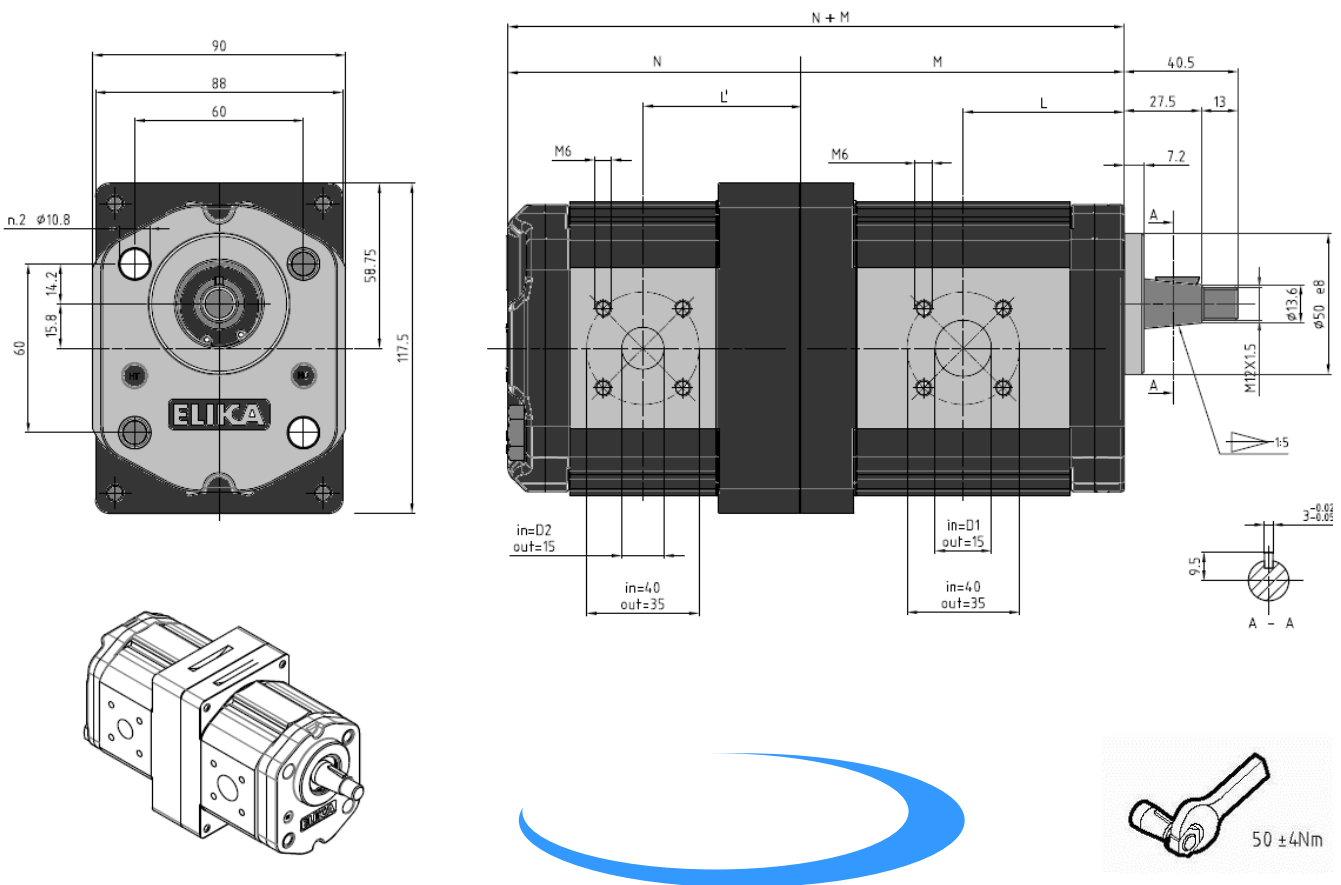

FRONT STAGE			
Pump Type	Displ. [cm <sup>3</sup> /rev]	Dimensions	
		L [mm]	M [mm]
ELI2-7.0	7.0	45.0	91.0
ELI2-8.2	8.2	46.0	93.0
ELI2-9.6	9.6	47.3	95.5
ELI2-11.4	11.4	48.8	98.5
ELI2-14.0	14.0	51.0	103.0
ELI2-16.1	16.1	52.8	106.5
ELI2-17.8	17.8	54.3	109.5
ELI2-21.0	21.0	57.0	115.0
ELI2-23.7	23.7	59.3	119.5
ELI2-25.7	25.7	61.0	123.0
ELI2-28.0	28.0	63.0	127.0
ELI2-35.0	35.1	69.0	139.0

REAR STAGE			
Pump Type	Displ. [cm <sup>3</sup> /rev]	Dimensions	
		L' [mm]	N [mm]
ELI2-7.0	7.0	61.5	109.5
ELI2-8.2	8.2	62.5	111.5
ELI2-9.6	9.6	63.8	114.0
ELI2-11.4	11.4	65.3	117.0
ELI2-14.0	14.0	67.5	121.5
ELI2-16.1	16.1	69.3	125.0
ELI2-17.8	17.8	70.8	128.0
ELI2-21.0	21.0	73.5	133.5
ELI2-23.7	23.7	75.8	138.0
ELI2-25.7	25.7	77.5	141.5
ELI2-28.0	28.0	79.5	145.5
ELI2-35.0	35.1	85.5	157.5

Accessories supplied with the standard pump: woodruff key (code 522055), M12x1.5 hexagonal nut (code 523016), washer (code 523005). Standard ports: M6 threads depth 13 mm. To mount the pump: n°2 M10 screws with a torque wrench setting fixed at 46±4 Nm. Please strictly follow assembly and use indications given in this catalogue for top performance and longer life of the ELI Marzocchi series. It is also very important to equip the hydraulic system with a proper filtering unit.

# ELI2BK7

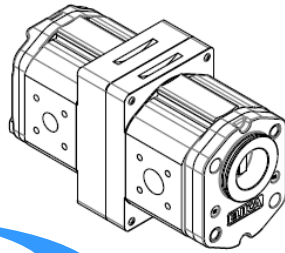
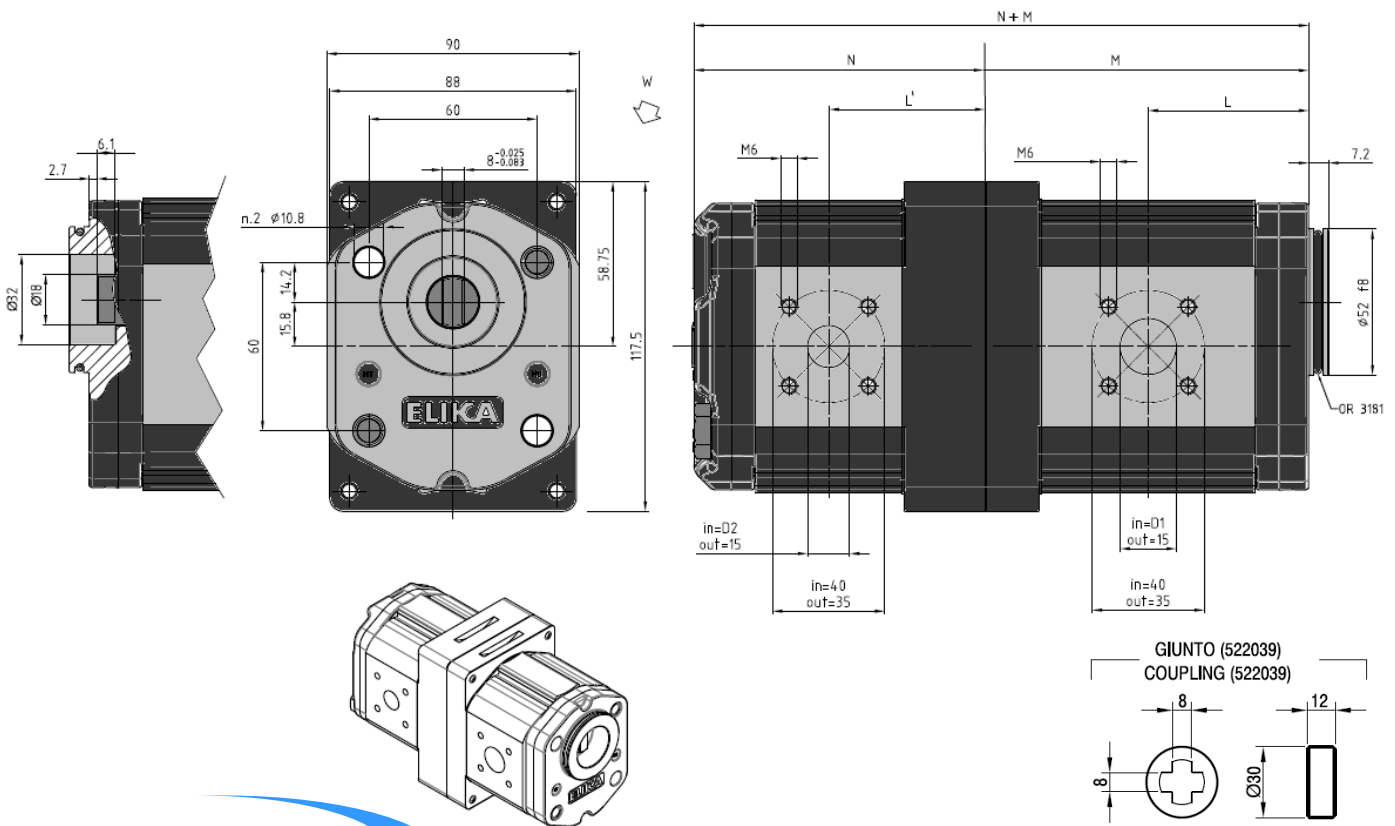

FRONT STAGE			
Pump Type	Displ. [cm <sup>3</sup> /rev]	Dimensions	
		L [mm]	M [mm]
ELI2-7.0	7.0	45.0	91.0
ELI2-8.2	8.2	46.0	93.0
ELI2-9.6	9.6	47.3	95.5
ELI2-11.4	11.4	48.8	98.5
ELI2-14.0	14.0	51.0	103.0
ELI2-16.1	16.1	52.8	106.5
ELI2-17.8	17.8	54.3	109.5
ELI2-21.0	21.0	57.0	115.0
ELI2-23.7	23.7	59.3	119.5
ELI2-25.7	25.7	61.0	123.0
ELI2-28.0	28.0	63.0	127.0
ELI2-35.0	35.1	69.0	139.0

REAR STAGE			
Pump Type	Displ. [cm <sup>3</sup> /rev]	Dimensions	
		L' [mm]	N [mm]
ELI2-7.0	7.0	61.5	109.5
ELI2-8.2	8.2	62.5	111.5
ELI2-9.6	9.6	63.8	114.0
ELI2-11.4	11.4	65.3	117.0
ELI2-14.0	14.0	67.5	121.5
ELI2-16.1	16.1	69.3	125.0
ELI2-17.8	17.8	70.8	128.0
ELI2-21.0	21.0	73.5	133.5
ELI2-23.7	23.7	75.8	138.0
ELI2-25.7	25.7	77.5	141.5
ELI2-28.0	28.0	79.5	145.5
ELI2-35.0	35.1	85.5	157.5

Standard ports: M6 threads depth 13 mm. To mount the pump: n°2 M10 screws with a torque wrench setting fixed at 46±4 Nm. Please strictly follow assembly and use indications given in this catalogue for top performance and longer life of the ELI Marzocchi series. It is also very important to equip the hydraulic system with a proper filtering unit.

**Medium element**

Rear stage

Front stage

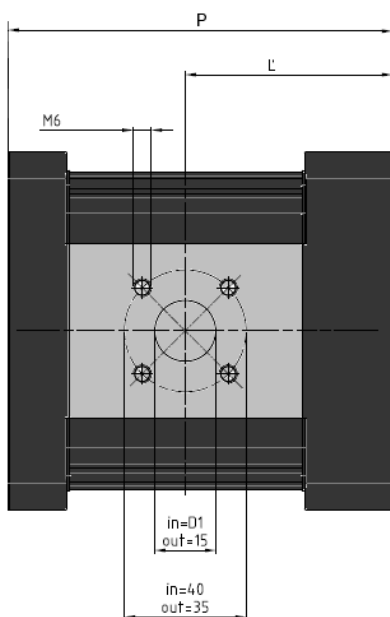

MEDIUM ELEMENT			
Pump Type	Displ. [cm <sup>3</sup> /rev]	Dimensions	
		L' [mm]	P [mm]
ELI2-7.0	7.0	61.5	106.5
ELI2-8.2	8.2	62.5	108.5
ELI2-9.6	9.6	63.8	111.0
ELI2-11.4	11.4	65.3	114.0
ELI2-14.0	14.0	67.5	118.5
ELI2-16.1	16.1	69.3	122.0
ELI2-17.8	17.8	70.8	125.0
ELI2-21.0	21.0	73.5	130.5
ELI2-23.7	23.7	75.8	135.0
ELI2-25.7	25.7	77.5	138.5
ELI2-28.0	28.0	79.5	142.5
ELI2-35.0	35.1	85.5	154.5

To obtain the total size of a multi-stage pump, add to the size of the double pump (M+N) the size of the intermediate stages (M+N+P+P\*..).  
**ELI Multiple pumps are provided by Marzocchi completely assembled, the customer or the installer can not modify the original configuration.**

**FLANGE / FLANGES**

**ALBERI / SHAFTS**

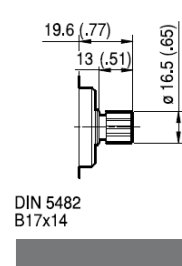
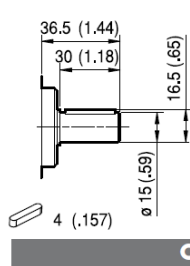
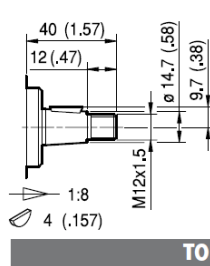
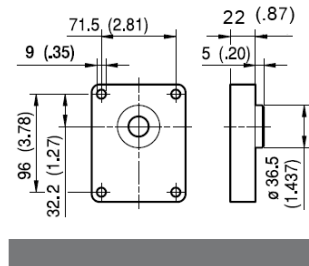

**T0**  
Coppia Max  
Max Torque 145 Nm

**C0**  
Coppia Max  
Max Torque 125 Nm

**S0**  
Coppia Max  
Max Torque 130 Nm

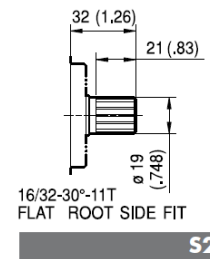
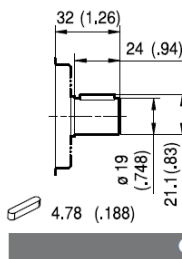
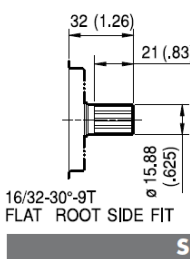
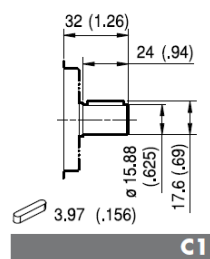
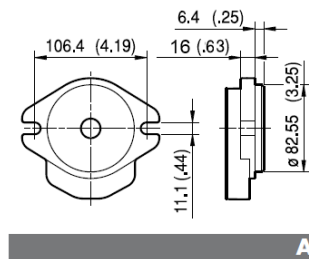

**A**  
Coppia Max  
Max Torque 105 Nm

**S1**  
Coppia Max  
Max Torque 110 Nm

**C2**  
Coppia Max  
Max Torque 150 Nm

**S2**  
Coppia Max  
Max Torque 230 Nm

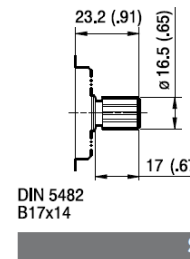
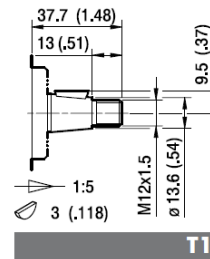
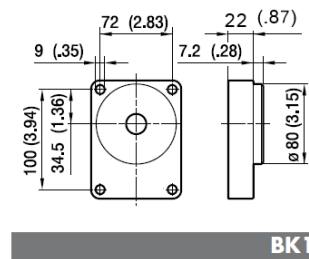

**BK1**  
Coppia Max  
Max Torque 130 Nm

**T1**  
Coppia Max  
Max Torque 130 Nm

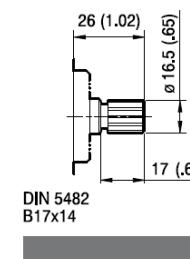
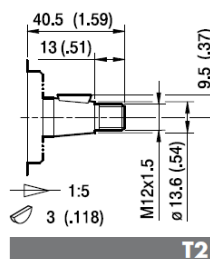
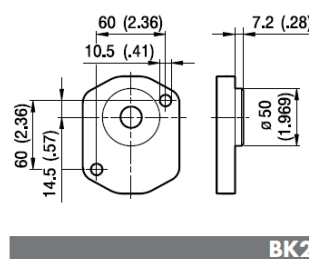

**BK2**  
Coppia Max  
Max Torque 130 Nm

**T2**  
Coppia Max  
Max Torque 130 Nm



**FLANGE / FLANGES**

**ALBERI / SHAFTS**

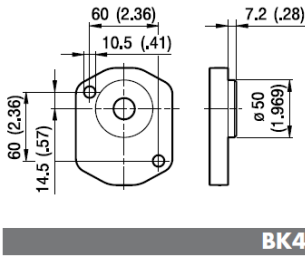

**BK4**

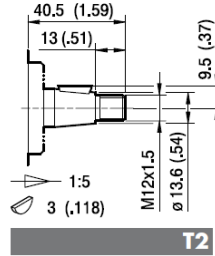

**T2**

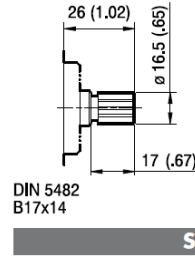

**S4**

Coppia Max  
Max Torque 130 Nm

Coppia Max  
Max Torque 130 Nm

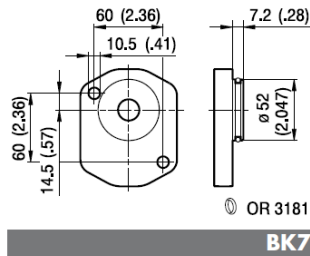

**BK7**

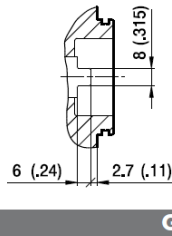

**G0**

Coppia Max  
Max Torque 105 Nm

Maximum torque ratings are referred to ideal working conditions; such values may reduce based on the quality of joints and connections used..

**PORTE / PORTS**

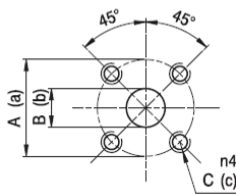

**D**

Tipo Type	Aspirazione Inlet			Mandata Outlet		
	A	B	C	a	b	c
ELI 7.0 + 8.2	40	15	M6	35	15	M6
ELI 9.6 + 35.0	40	19	M6	35	15	M6

Tightening torques for M6 screws 10 Nm.

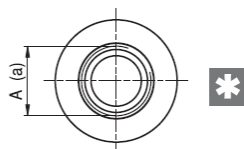

STANDARD SAE J1926/1

**FA**

Type Tipo	Aspirazione Inlet	Mandata Outlet
	A	a
ELI 7.0 + 28.0	1 1/16-12 UNF	7/8-14 UNF
ELI 14.0 + 35.0	1 5/16-12 UNF	7/8-14 UNF

Tightening torques for 7/8-14 UNF fitting 50 Nm.  
Tightening torques for 1 1/16-12 UNF and 1 5/16-12 UNF fitting 60 Nm.



A reduction of body fatigue strength may occur if the pump is working at elevated and intermittent pressures. For further details please contact our Sales and Technical Dept. we suggest to provide application specification through our PID form.



**Sum of pump noise level**

To add two noise level values in decibel can be used the following formula or the graph shown on side.

$$\text{Sum dBA} = 10 \text{ Log} (10^{\text{dBA}_A/10} + 10^{\text{dBA}_B/10})$$

In the graph the abscissa axis represents the arithmetic difference between the values to be added  $\text{dBA}_A - \text{dBA}_B$ , the ordinate axis shows the value to be added to the greater of the two values  $\text{dBA}_A$  to obtain the sum of dBA.

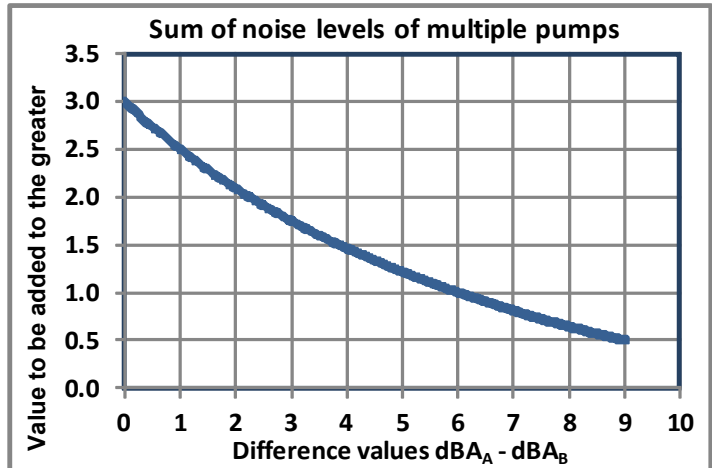

**EXAMPLE:**

Pump type: ELI2-D-14.0/9.6

Rotation speed = 1500 rpm

Operating pressure front element = 250 bar

Operating pressure rear element = 150 bar

Noise level front element  $\text{dBA}_A = 56$  dBA (graphs pag. 19)

Noise level rear element  $\text{dBA}_B = 53$  dBA

Difference between the values to be added  $\text{dBA}_A - \text{dBA}_B = 3$

Value to be added to  $\text{dBA}_A = 1.8$

Noise level multiple pump =  $56 + 1.8 = 57.8$  dBA

In the case in which the double pump have two stages of equal displacement, operating at the same pressure, just add to the noise single value 3 dBA.

**Verification of the limit of transmitted torque**

The maximum transmissible torque between the elements is 100 Nm; therefore in the case of double pumps there are no restrictions on configurations. It is still need to check the resistance of the front shaft. Must verify that the total torque to be transmitted will be less than the upper limit of the shaft (pag. 14, 15). For each stage, calculate the maximum torque with the formula (3) or from the graphs on pag. 17, 18. Add the values obtained and to verify if they fare lower than the maximum defined for the shaft chose.

**EXAMPLE:**

Poump type: ELI2-D-14.0/9.6–T0

Operating pressure front element = 250 bar

Operating pressure rear element = 150 bar

Torque front element = 60 Nm (graphs pag. 17, 18)

Torque rear element = 26 Nm (<100Nm)

Maximum torque transmitted from front shaft =  $60 + 27 = 87$  Nm

Maximum torque shaft type T0 = 145 Nm > 87 Nm

Shaft checked



ELI2-7.0

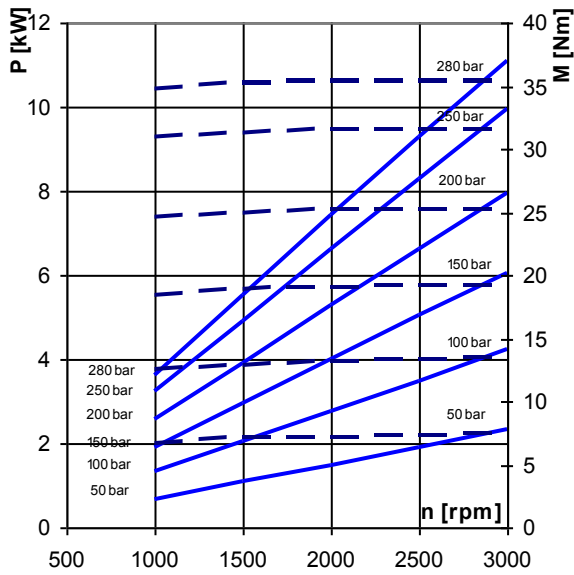

ELI2-8.2

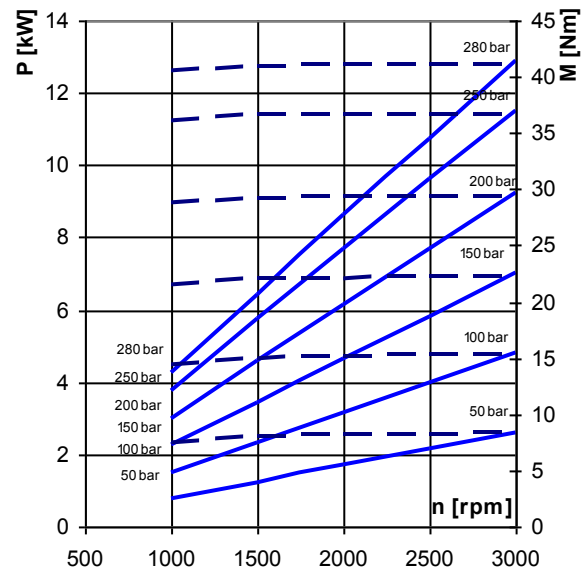

ELI2-9.6

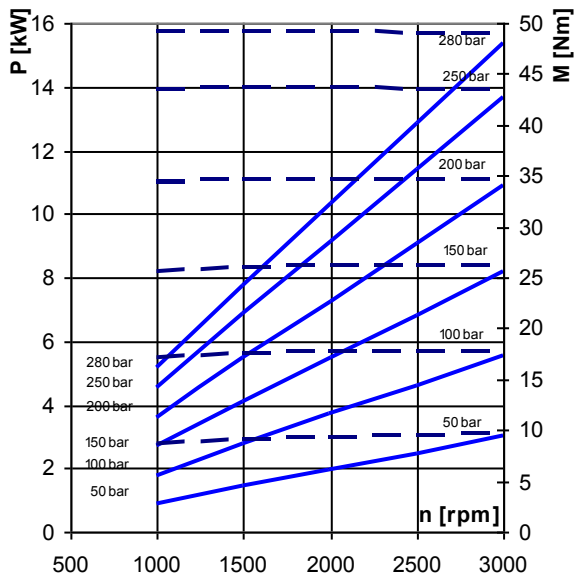

ELI2-11.4

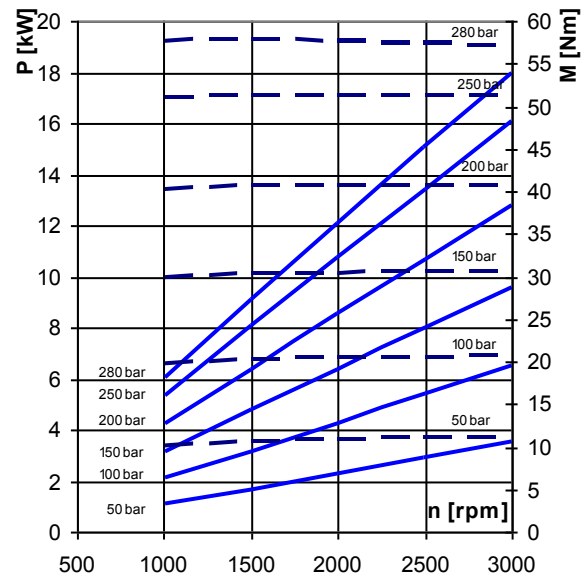

ELI2-14.0

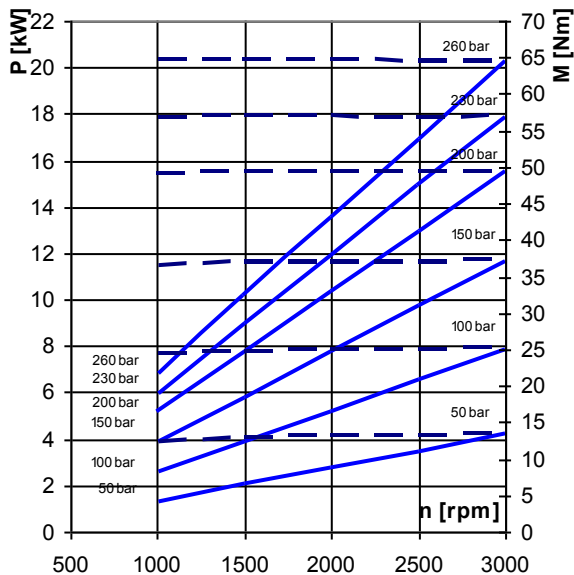

ELI2-16.1

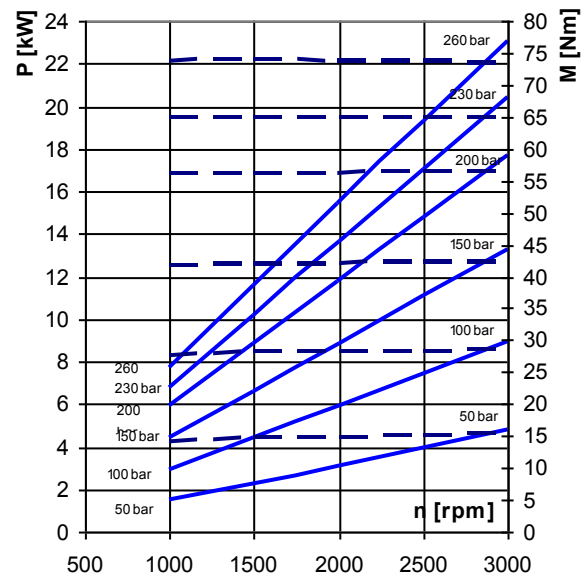

**ELI2-17.8**

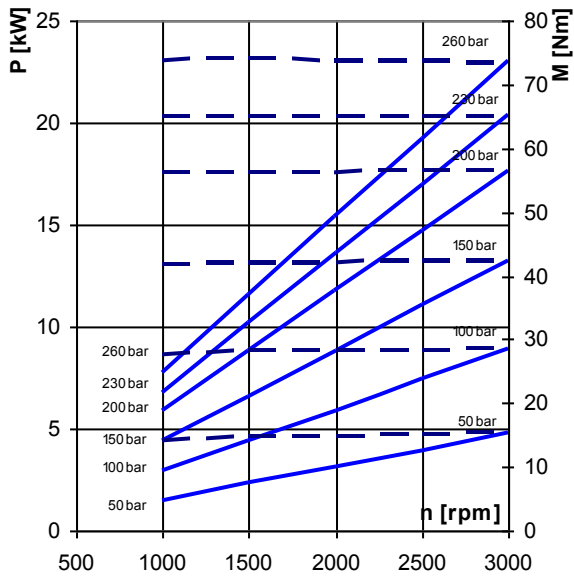

**ELI2-21.0**

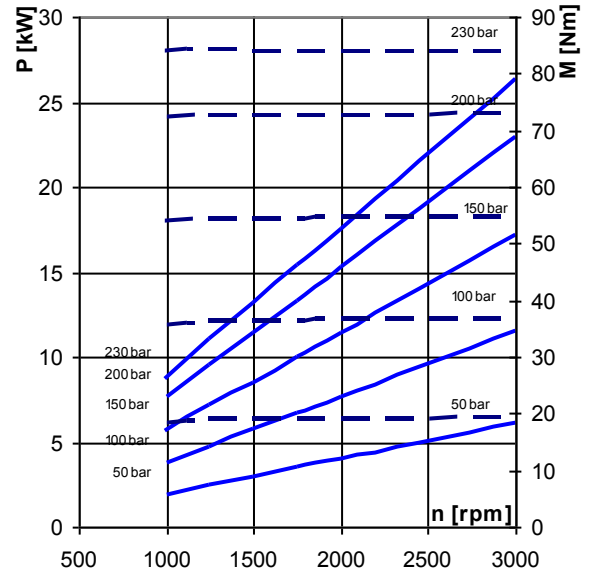

**ELI2-23.7**

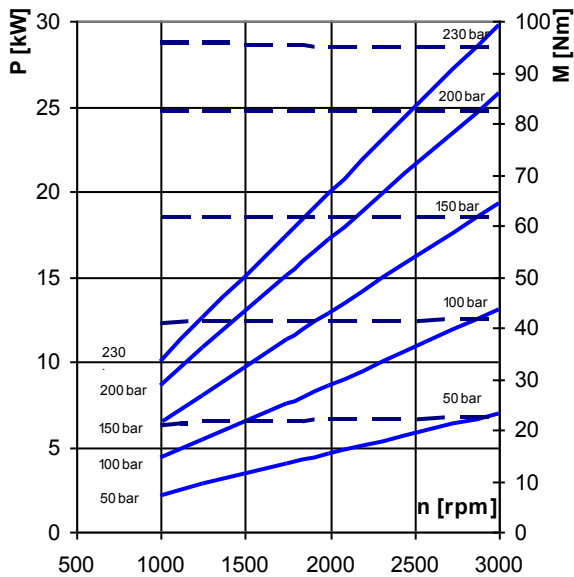

**ELI2-25.7**

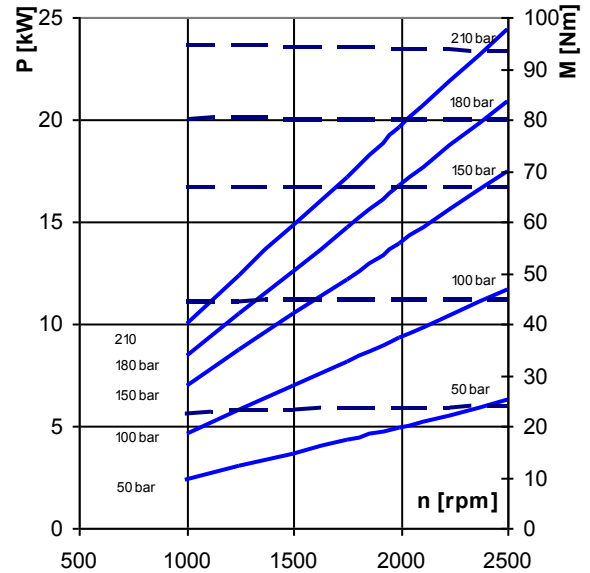

**ELI2-28.0**

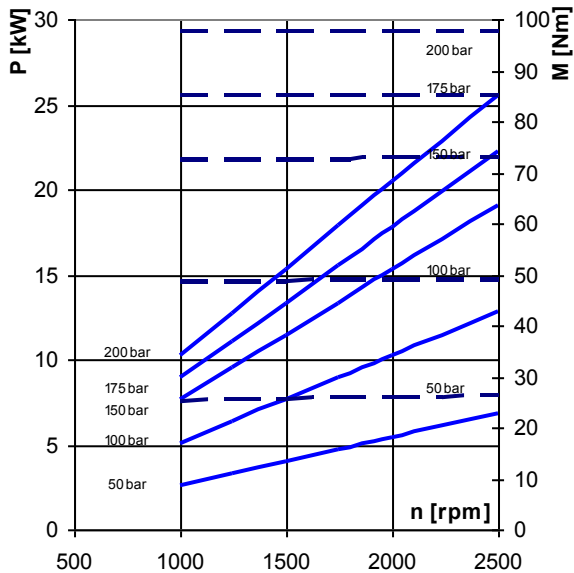

**ELI2-35.0**

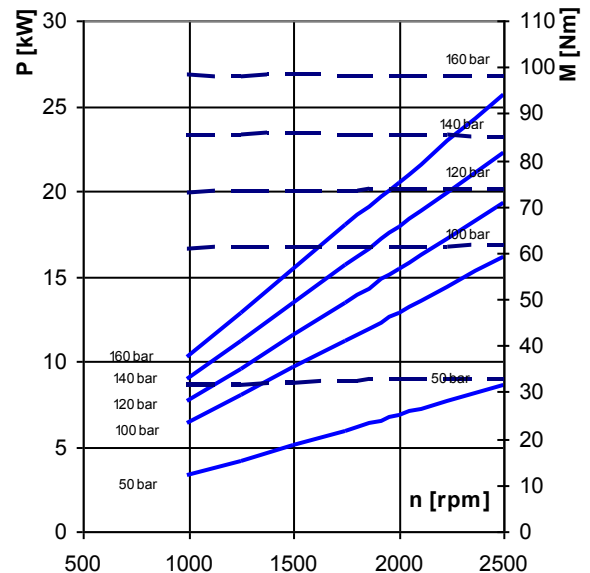

ELI2-7.0 / ELI2-8.2

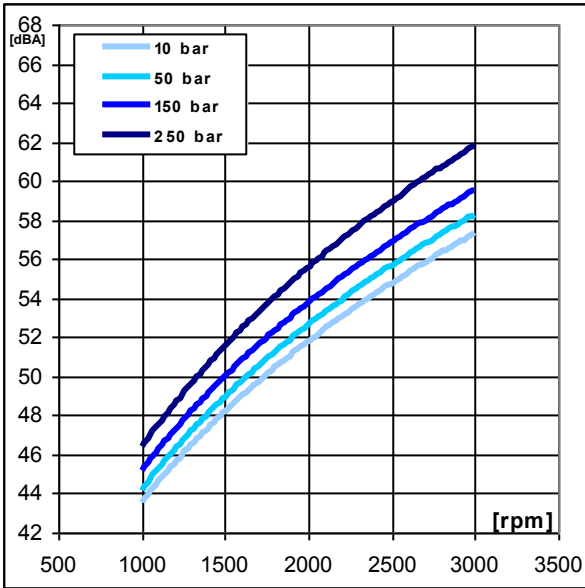

ELI2-9.6 / ELI2-11.4

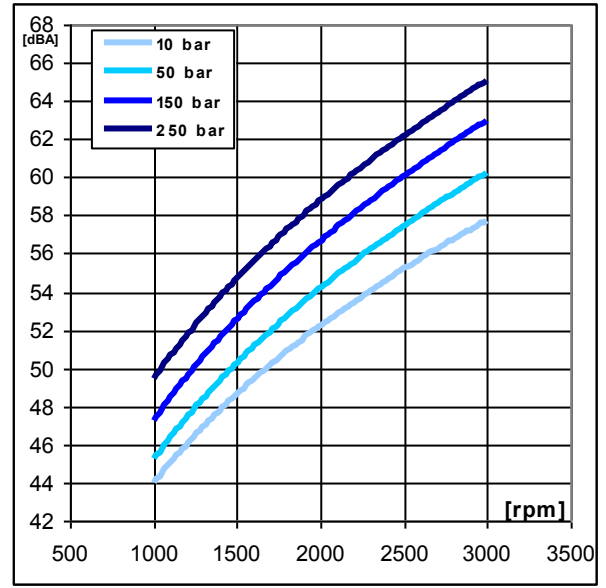

ELI2-14.0 / ELI2-16.1

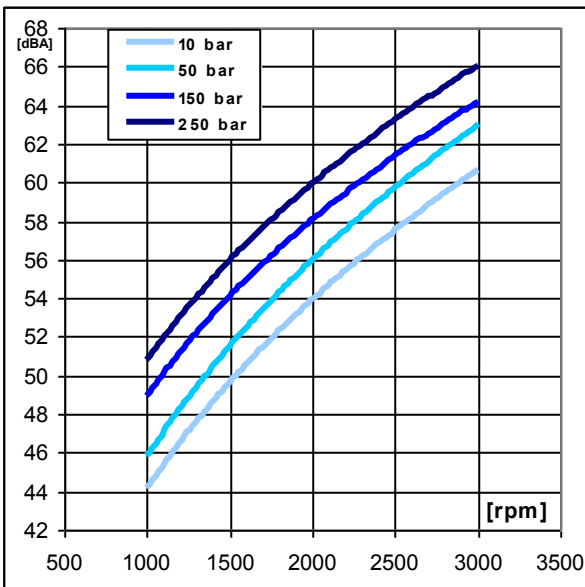

ELI2-17.8 / ELI2-21.0

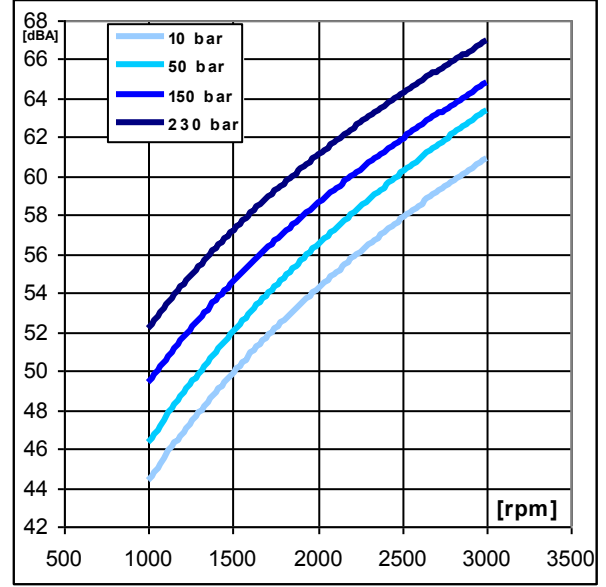

ELI2-23.7 / ELI2-25.7

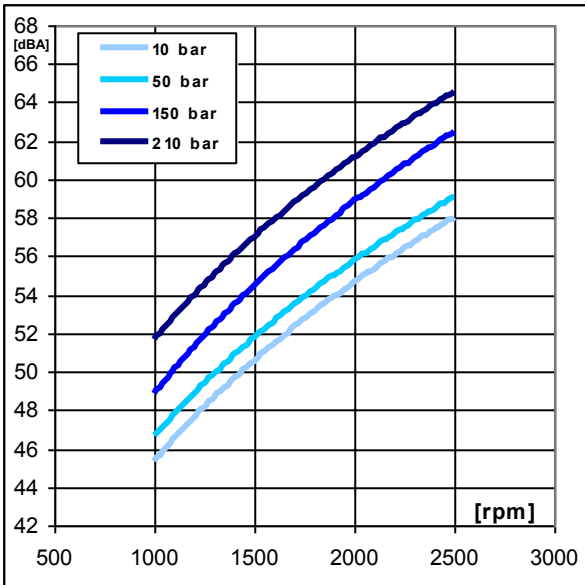

ELI2-28.0 / ELI2-35.0

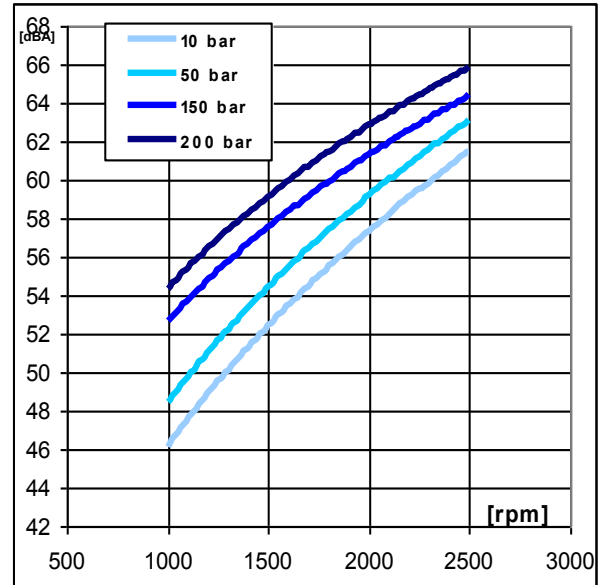



**ELIKA**<sup>®</sup>  
by **MARZOCCHI**



**Standard gear pump profile**



**ELIKA gear pump profile**



Noise comparison between:  
standard external gear pump,  
dual flank gear pump,  
internal gear pump,  
vane pump,  
ELIKA pump.  
The low pulsation reduces the induced vibration in the machines. The lower frequency of the ELIKA pump produces a more pleasant sound.

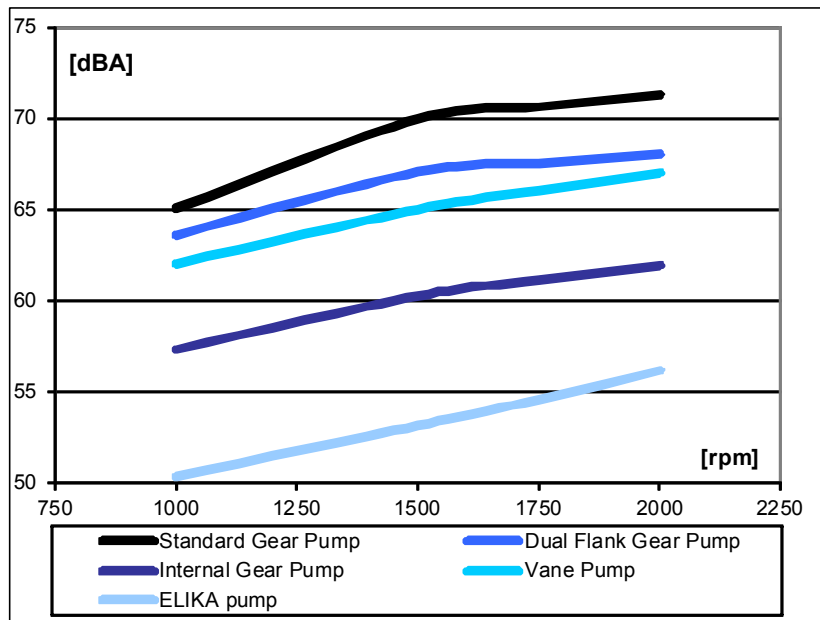

La Marzocchi Pompe declina ogni responsabilità legata ad eventuali errori generati nella redazione del presente catalogo. Fermo restando le caratteristiche generali e le condizioni di impiego indicate, i dati contenuti in questa pubblicazione sono forniti a titolo indicativo e ci riserviamo il diritto di variare le caratteristiche tecniche della produzione senza preavviso. Le applicazioni delle pompe e dei motori che richiedono una particolare affidabilità di funzionamento (es. apparecchiature aeronautiche, aerospaziali, militari, nucleari, ecc.) dovranno essere specificate nell'ordine e da noi espressamente autorizzate per iscritto.

