

# CPV



## Push-pull female couplings for agriculture, panel mounting.

Push-pull couplings, designed for panel mounting installation. A wide range of threaded adapters is available. Breakaway function. ISO 7241-1 part A interchange.

## Applications

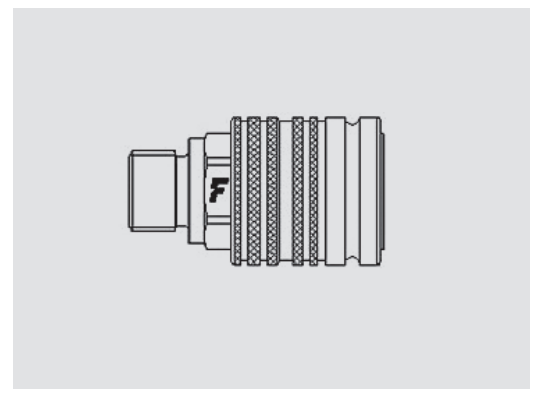

## Technical Specifications

dash	Size		Working Pressure (MPa)	Flow Rate (l/min)	Spillage (ml)	Force to Connect (N)	Burst pressure (MPa)		
	mm	inch					Male	Female	Male + Female
06	10	3/8"	27	24	1,3	120	130	110	
08	12,5	1/2"	25	75	1,8	110	120	100	
16	25	1"	22	270	13	220	110	90	

Material	<b>Steel</b>
Seals	<b>NBR</b>
Working temperatures	<b>- 25 °C to + 125 °C</b>
Surface treatment	<b>MATE 500 (CrIII)</b>
Series Interchange	<b>ISO 7241-A</b>
Valve Type	<b>Poppet</b>
Connection	<b>Push to Connect*</b>
Disconnection	<b>Pull to Disconnect*</b>
Connection Under Pressure	<b>Not Allowed</b>

\* If panel mounted through the sleeve. Otherwise sleeve retraction.

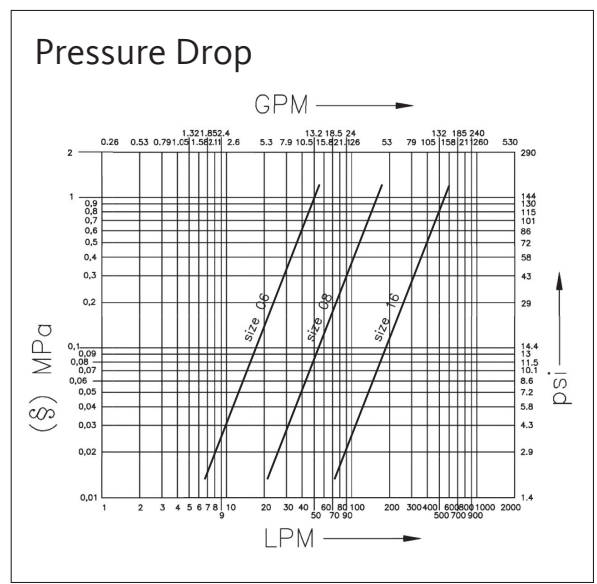

**CPV**

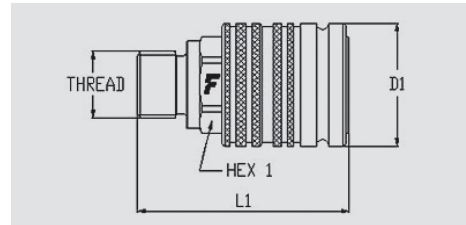

Size		Thread details			FEMALE						
inch	mm	Thread Type	Standard	Thread	Part Number	L (L1 + Thread)		D1		HEX1	
						mm	inch	mm	inch	mm	inch
3/8"	10	01/ METRIC	ISO 6149-2	M16x1,5 MALE	CPV061/1615 F	62	2,44	33	1,3	24	0,94
3/8"	10	02/ METRIC	ISO 8434-1-L	M12x1,5 MALE 6L	CPV062/1215 F	60,7	2,39	33	1,3	24	0,94
3/8"	10	02/ METRIC	ISO 8434-1-L	M16x1,5 MALE 10L	CPV062/1615 F	61,7	2,43	33	1,3	24	0,94
3/8"	10	07/ METRIC	ISO 8434-1-L	M14x1,5 MALE BULKHEAD SHORT 8L	CPV067/1415 F	76,7	3,02	33	1,3	24	0,94
3/8"	10	F BSPP	ISO 1179-1	BSPP 1/2 FEMALE	CPV06 12 GAS F	65,5	2,58	33	1,3	24	0,94
3/8"	10	F BSPP	ISO 1179-1	BSPP 3/8 FEMALE	CPV06 38 GAS F	64,5	2,54	33	1,3	24	0,94
1/2"	12,5	0/ BSPP	BS 5380	1/2 BSP FEMALE ORB	CPV080/12GAS F	66,3	2,61	38	1,5	27	1,06
1/2"	12,5	0/ BSPP	BS 5380	3/8 BSP FEMALE ORB	CPV080/38GAS F	62,3	2,45	38	1,5	27	1,06
1/2"	12,5	0/ METRIC	ISO 6149-1	M18x1,5 FEMALE ORB	CPV080/1815 F	62,3	2,45	38	1,5	27	1,06
1/2"	12,5	0/ METRIC	ISO 6149-1	M22x1,5 FEMALE ORB	CPV080/2215 F	66,3	2,61	38	1,5	27	1,06
1/2"	12,5	0/ SAE	ISO 11926-1	3/4"-16 UNF FEMALE ORB	CPV080/12SAE F	66,3	2,61	38	1,5	27	1,06
1/2"	12,5	0/ SAE	ISO 11926-1	7/8"-14 UNF FEMALE ORB	CPV080/58SAE F	62,3	2,45	38	1,5	27	1,06
1/2"	12,5	01/ METRIC	ISO 6149-2	M22x1,5 MALE	CPV081/2215 F	66,3	2,61	38	1,5	27	1,06
1/2"	12,5	01/ SAE	ISO 11926-3	3/4"-16 UNF MALE	CPV081/12SAE F	62,4	2,46	38	1,5	27	1,06
1/2"	12,5	02/ METRIC	ISO 8434-1-L	M14x1,5 MALE 8L	CPV082/1415 F	64,3	2,53	38	1,5	27	1,06
1/2"	12,5	02/ METRIC	ISO 8434-1-L	M16x1,5 MALE 10L	CPV082/1615 F	63,8	2,51	38	1,5	27	1,06
1/2"	12,5	02/ METRIC	ISO 8434-1-L	M18x1,5 MALE 12L	CPV082/1815 F	62,3	2,45	38	1,5	27	1,06
1/2"	12,5	02/ METRIC	ISO 8434-1-L	M20x1,5 MALE 12S	CPV082/2015 F	63,3	2,49	38	1,5	27	1,06
1/2"	12,5	02/ METRIC	ISO 8434-1-L	M22x1,5 MALE 15L	CPV082/2215 F	62,3	2,45	38	1,5	27	1,06
1/2"	12,5	02/ METRIC	ISO 8434-1-L	M26x1,5 MALE 18L	CPV082/2615 F	62,3	2,45	38	1,5	27	1,06
1/2"	12,5	03/ METRIC	ISO 8434-1-S	M20x1.5 MALE 12S	CPV083/2015 F	62,3	2,45	38	1,5	27	1,06
1/2"	12,5	03/ METRIC	ISO 8434-1-S	M24x1,5 MALE 16S	CPV083/2415 F	65,3	2,57	38	1,5	27	1,06
1/2"	12,5	04/ BSPP	ISO 8434-6	60° 1/2" BSPP MALE BULKHEAD	CPV084/12GAS F	87,8	3,46	38	1,5	27	1,06
1/2"	12,5	04/ BSPP	ISO 8434-6	60° 3/8" BSPP MALE BULKHEAD	CPV084/38GAS F	87,8	3,46	38	1,5	27	1,06
1/2"	12,5	05/ METRIC	ISO 8434-1-L	M16x1,5 MALE BULKHEAD 10L	CPV085/1615 F	86,3	3,4	38	1,5	27	1,06
1/2"	12,5	05/ METRIC	ISO 8434-1-L	M18x1,5 MALE BULKHEAD 12L	CPV085/1815 F	86,3	3,4	38	1,5	27	1,06

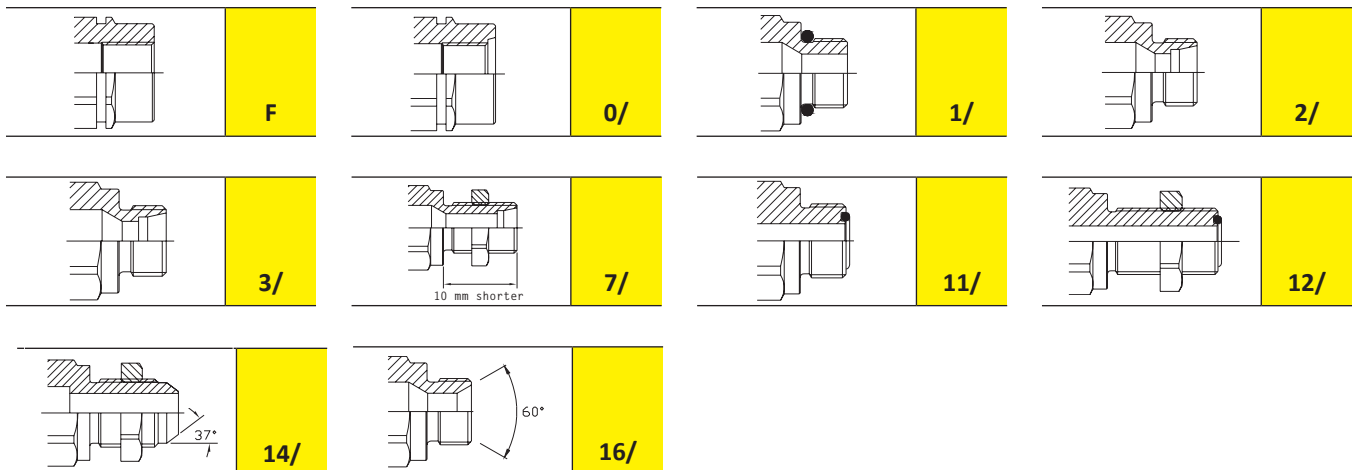

# CPV

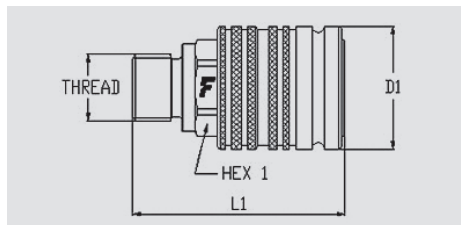

Size		Thread details			FEMALE						
inch	mm	Thread Type	Standard	Thread	Part Number	L (L1 + Thread)		D1		HEX1	
						mm	inch	mm	inch	mm	inch
1/2"	12,5	05/ METRIC	ISO 8434-1-L	M22x1,5 MALE BULKHEAD 15L	CPV085/2215 F	86,3	3,4	38	1,5	27	1,06
1/2"	12,5	06/ METRIC	ISO 8434-1-S	M20x1.5 MALE BULKHEAD 12S	CPV086/2015 F	86,3	3,4	40	1,57	27	1,06
1/2"	12,5	07/ METRIC	ISO 8434-1-L	M16x1,5 MALE BULKHEAD SHORT 10L	CPV087/1615 F	78,8	3,1	38	1,5	27	1,06
1/2"	12,5	07/ METRIC	ISO 8434-1-L	M18x1.5 MALE BULKHEAD SHORT 12L	CPV087/1815 F	77,3	3,04	38	1,5	27	1,06
1/2"	12,5	07/ METRIC	ISO 8434-1-L	M22x1.5 MALE BULKHEAD SHORT 15L	CPV087/2215 F	77,3	3,04	38	1,5	27	1,06
1/2"	12,5	07/ METRIC	ISO 8434-1-L	M26x1.5 MALE BULKHEAD SHORT 18L	CPV087/2615 F	90,8	3,57	40	1,57	30	1,18
1/2"	12,5	11/ SAE	ISO 8434-3	13/16"-16 UN MALE ORFS	CPV0811/12SAEF	64,1	2,52	38	1,5	27	1,06
1/2"	12,5	12/ SAE	ISO 8434-3	1"-14 UNS MALE BULKHEAD ORFS	CPV0812/58SAEF	96	3,78	38	1,5	34	1,34
1/2"	12,5	12/ SAE	ISO 8434-3	13/16"-16 UN MALE BULKHEAD ORFS	CPV0812/12SAEF	85,8	3,38	38	1,5	27	1,06
1/2"	12,5	14/ SAE	ISO 8434-2	3/4"-16 UN MALE BULKHEAD JIC	CPV0814/12SAEF	87,9	3,46	38	1,5	27	1,06
1/2"	12,5	16/ BSPP	ISO 8434-6	60° 1/2 BSPP MALE	CPV0816/12GASF	65	2,56	38	1,5	27	1,06
1/2"	12,5	16/ METRIC	ISO 8434-6	60° 18x1,5 METRIC MALE	CPV0816/1815 F	65,3	2,57	38	1,5	27	1,06
1/2"	12,5	F BSPP	ISO 1179-1	BSPP 3/8 FEMALE	CPV08 38 GAS F	62,3	2,45	30	1,18	27	1,06
1/2"	12,5	F METRIC	ISO 9974-1	M22x1,5 FEMALE	CPV08 2215 F	66	2,6	38	1,5	27	1,06
1"	25	0/ BSPP	BS 5380	1 BSP FEMALE ORB	CPV160/1GAS F	100,3	3,95	54	2,13	42	1,65
1"	25	0/ BSPP	BS 5380	3/4 BSP FEMALE ORB	CPV160/34GAS F	97,3	3,83	54	2,13	38	1,5
1"	25	0/ SAE	ISO 11926-1	1-5/16"-12 UN FEMALE ORB	CPV16 1SAE F	100,3	3,95	54	2,13	42	1,65
1"	25	02/ METRIC	ISO 8434-1-L	M26x1,5 MALE 18L	CPV162/2615 F	96,3	3,79	54	2,13	38	1,5
1"	25	02/ METRIC	ISO 8434-1-L	M30x2 MALE 22L	CPV162/302 F	96,8	3,81	54	2,13	38	1,5
1"	25	03/ METRIC	ISO 8434-1-S	M30x2 MALE 20S	CPV163/302 F	100,3	3,95	54	2,13	38	1,5
1"	25	05/ METRIC	ISO 8434-1-L	M26x1,5 MALE BULKHEAD 18L	CPV165/2615 F	124,3	4,89	54	2,13	38	1,5
1"	25	05/ METRIC	ISO 8434-1-L	M30x2 MALE BULKHEAD 22L	CPV165/302 F	116,8	4,6	54	2,13	41	1,61
1"	25	05/ METRIC	ISO 8434-1-L	M36x2 MALE BULKHEAD 28L	CPV165/362 F	113,8	4,48	54	2,13	42	1,65
1"	25	F BSPP	ISO 1179-1	BSPP 1 FEMALE	CPV16 1GAS F	102,3	4,03	54	2,13	42	1,65
1"	25	F BSPP	ISO 1179-1	BSPP 3/4 FEMALE	CPV16 34GAS F	97,3	3,83	54	2,13	38	1,5

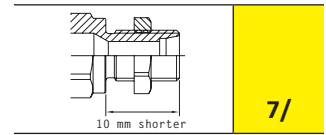
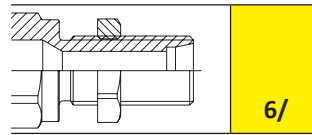
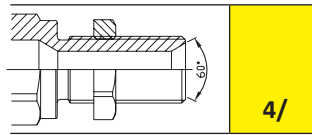
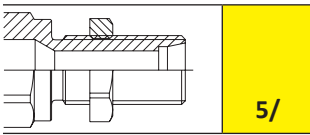
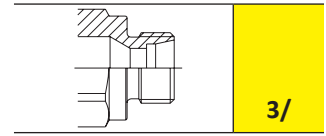
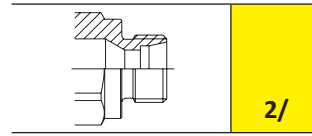
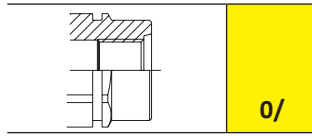
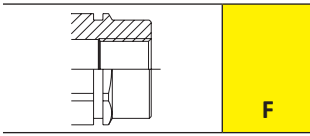

# CPV Accessories



**PVC Plugs suitable for FEMALE**



**PVC Plugs suitable for FEMALE**

Size			Plug Details		Size			Plug Details	
inch	mm	dash	Part number	Colour	inch	mm	dash	Part number	Colour
3/8"	10	06	TMA 38	yellow	1/2"	12,5	08	TM 12-38	blue
3/8"	10	06	TMA 38 A	orange	1/2"	12,5	08	TM 12-38 G	yellow
3/8"	10	06	TMA 38 B	blue	1/2"	12,5	08	TM 12-38 GR	grey
3/8"	10	06	TMA 38 N	black	1/2"	12,5	08	TM 12-38 M	brown
3/8"	10	06	TMA 38 R	red	1/2"	12,5	08	TM 12-38 N	black
3/8"	10	06	TMA 38 V	green	1/2"	12,5	08	TM 12-38 R	red
1/2"	12,5	08	TM 12 L	blue	1/2"	12,5	08	TM 12-38 V	green
1/2"	12,5	08	TM 12 L/A	orange	 <p><b>Aluminium plugs suitable for FEMALE</b></p>				
1/2"	12,5	08	TM 12 L/G	yellow					
1/2"	12,5	08	TM 12 L/M	brown					
1/2"	12,5	08	TM 12 L/N	black					
1/2"	12,5	08	TM 12 L/R	red					
1/2"	12,5	08	TM 12 L/V	green					
1"	25	16	TMA 1	yellow	Size			Plug Details	
1"	25	16	TMA 1 N	black	inch	mm	dash	Part number	Colour
1"	25	16	TMA 1 R	red	1/2"	12,5	08	TM 12 S	

## Seal Kits



### For Female

Size			Seal Details	
inch	mm	dash	Material	Part Number
3/8"	10	06	NBR; PTFE	SK ANV 38
1/2"	12,5	08	NBR; PTFE	SK NV 12
1"	25	16	NBR; PTFE	SK ANV 1

Every seals kit is composed of 5 or 10 pcs.