

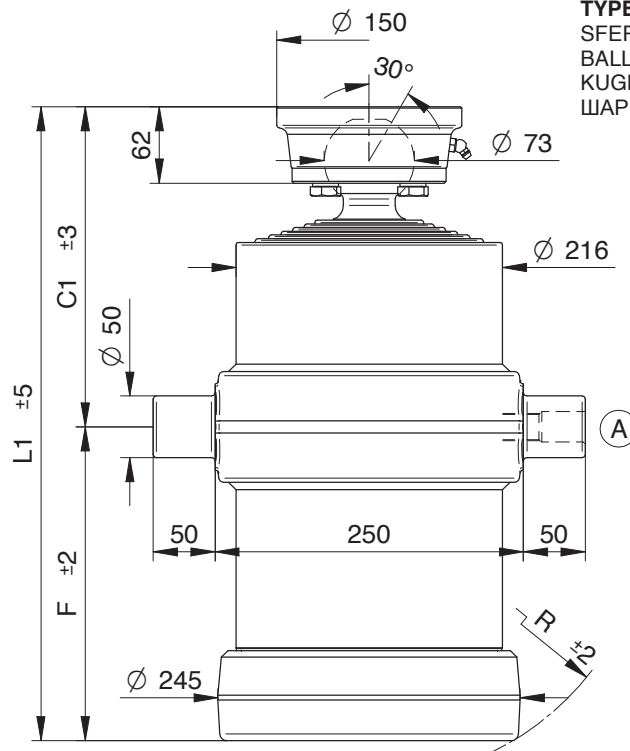

CILINDRI TELESCOPICI CON 6 SFILATE
TELESCOPIC CYLINDERS WITH 6 EXTENSIONS

TELESKOPZYLINDER MIT 6 STUFEN
ШЕСТИСТУПЕНЧАТЫЕ ТЕЛЕСКОПИЧЕСКИЕ ЦИЛИНДРЫ



TYPE S :
SFERA
BALL
KUGEL
ШАП

STANDARD

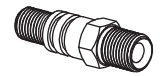

(A) 26100000 3/4 gas

OPTIONAL

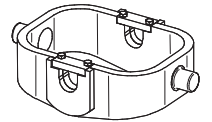

CULLA7

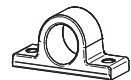

SUP050



SUP050-A

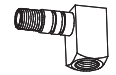

26320000

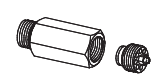

27230000

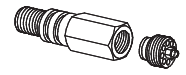

71780000 1/2 Gas
71560000 3/4 Gas

NORME DI SICUREZZA E PRECAUZIONI
DI MONTAGGIO, VEDI Pag. 6
IMPORTANT SAFETY INSTRUCTIONS AND
PRECAUTIONS FOR MOUNTING, Page 6
SICHERHEITSBESTIMMUNGEN UND
VORSICHTSMAßNAHMEN FÜR DEN EINBAU, Page 7
МЕРЫ ПО ОБЕСПЕЧЕНИЮ БЕЗОПАСНОСТИ И
ИНСТРУКЦИЯ ПО ПРАВИЛЬНОМУ МОНТАЖУ, стр. 7

KIT GUARNIZIONI, SEALS KIT, DICHTUNGSSATZ, НАБОР ПРОКЛАДОК : SGS088-187

PESO TOT. RIBALTABILE 25 Ton. a 180 bar
TOTAL WEIGHT TIP-UP 25 Ton. 180 bar

GESAMTGEWICHT ANHÄNGER 25 Ton. 180 bar
ПОЛНЫЙ ВЕС КУЗОВА 25 Тонн. при 180 бар

| TIPO TYPE TYP ВИД | DISEGNO - DRAWING ZEICHNUNG - ЧЕРТЕЖ | CORSO - STROKE HUB - ХОД | Ø SFILATE Ø EXTENSIONS Ø STUFEN Ø СТУПЕНИ | | | | | | | | DIMENSIONI CILINDRO CYLINDER DIMENSIONS ZYLINDER ABMESSUNGEN РАЗМЕРЫ ЦИЛИНДРА | | | | | | L. sfilata - L. extension L. stufen - Ход ступени | Peso - Kg - Weight Вес - кг. - Gewicht | | Volume oil Lt. Amount of oil Lt. Ölinhalt Lt. Объем масла л. | |
|----------------------------|---|-----------------------------|--|--------------------|---------------------|---------------------|---------------------|---------------------|---------------------|---------------------|--|---|-----|-----|---|-----|--|---|---|---|----|
| | | | 68 TON. 6,5 | 88 TON. 10,9 | 107 TON. 16,1 | 126 TON. 22,4 | 145 TON. 29,7 | 165 TON. 38,4 | 187 TON. 49,4 | 210 TON. 62,3 | 236 TON. 78,5 | C | C' | F | L | L' | | R | F | | S |
| | | | | | | | | | | | | | | | | | | | | | |
| 6050 | 14040 | 1415 | | ● | ● | ● | ● | ● | ● | | | - | 260 | 195 | - | 455 | 230 | 320 | - | 100 | 22 |
| 6051 | 14041 | 1505 | | ● | ● | ● | ● | ● | ● | | | - | 260 | 210 | - | 470 | 244 | 335 | - | 104 | 23 |
| 6052 | 14042 | 1740 | | ● | ● | ● | ● | ● | ● | | | - | 260 | 255 | - | 515 | 283 | 380 | - | 114 | 28 |
| 6053 | 14043 | 2160 | | ● | ● | ● | ● | ● | ● | | | - | 260 | 325 | - | 585 | 348 | 450 | - | 128 | 34 |
| 6054 | 14044 | 2430 | | ● | ● | ● | ● | ● | ● | | | - | 260 | 375 | - | 635 | 395 | 500 | - | 139 | 38 |
| 6055 | 14045 | 2850 | | ● | ● | ● | ● | ● | ● | | | - | 260 | 445 | - | 705 | 462 | 570 | - | 154 | 45 |
| 6056 | 14046 | 3265 | | ● | ● | ● | ● | ● | ● | | | - | 260 | 525 | - | 785 | 535 | 650 | - | 171 | 51 |
| 6057 | 13910 | 3565 | | ● | ● | ● | ● | ● | ● | | | - | 260 | 575 | - | 835 | 590 | 700 | - | 181 | 56 |

PRESSIONE MAX. DI ESERCIZIO 220 BAR - WORKING MAX. PRESSURE 220 BAR
MAX. BETRIEBSDRUCK 220 BAR - МАКСИМАЛЬНОЕ РАБОЧЕЕ ДАВЛЕНИЕ 220 БАР

CARATTERISTICHE TECNICHE DATE A TITOLO PURAMENTE INDICATIVO E MODIFICABILI SENZA PREAVVISO - THESE TECHNICAL SPECIFICATIONS ARE ONLY APPROXIMATE VALUES AND MAY BE CHANGED WITHOUT ANY PREVIOUS NOTICE
DIESE TECHNISCHEN DATEN GELTEN NUR ALS RICHTWERTE UND KÖNNEN OHNE VORANMELDUNG GEÄNDERT WERDEN - ВЫШЕУКАЗАННЫЕ ТЕХНИЧЕСКИЕ ХАРАКТЕРИСТИКИ ЯВЛЯЮТСЯ ПРИБЛИЗИТЕЛЬНЫМИ И МОГУТ БЫТЬ ИЗМЕНЕНЫ БЕЗ ПРЕДВАРИТЕЛЬНОГО УВЕДОМЛЕНИЯ